

# *MFA Applications in Japan*

## *– Case Studies*

*Seiji Hashimoto*

*Senior Researcher, National Institute for Environmental Studies*



# My office in National Institute for Environmental Studies



- *Established in 2001*
- *7 Research Sections*
- 4 Core Research Projects*
- *40 Researchers (inc. PDF)*
- 40 Assistant Staffs*

***Research Center for Material Cycles and Waste Management***

**循環型社会・廃棄物研究センター**

Cycle  
Circulation  
Recycling

-Oriented  
-Based  
-Type

Society

Waste

Research Center

Junkan-gata society

# Today's talk

## ❑ What is “Junkan-Gata Society”?

- A driving force of expansion of material flow studies in Japan

## ❑ Topic 1: National material flow indicators and targets

- Outline, background, and ongoing discussion on policies related to the use of national material flow indicators

## ❑ Topic 2: MFA for construction minerals

- Dominate input materials and Net Additions to Stock (NAS) of national MFA

## ❑ Topic 3: Classification of stocked materials

- For future waste management and resource reutilization

## ❑ Topic 4: MFA for wood

- As a case for carbon accounting

# What is “Junkan-Gata Society”?

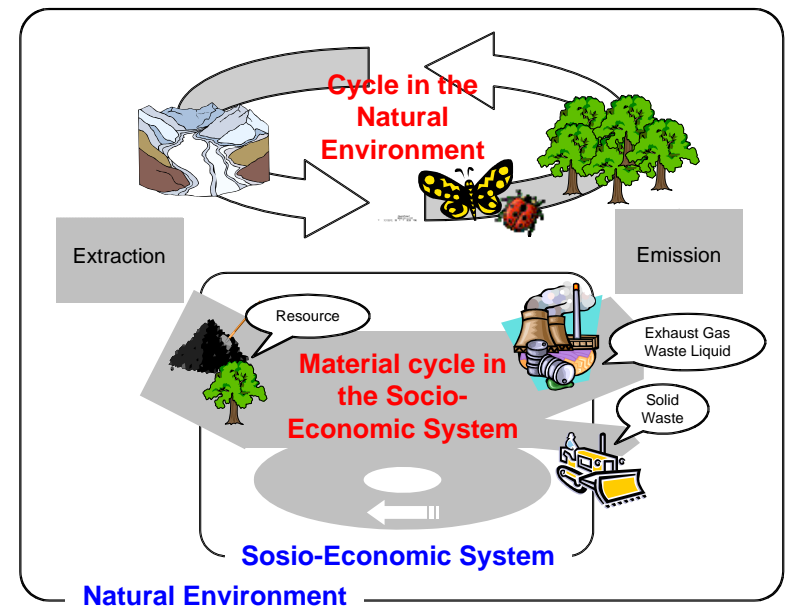

This section is based on Hashimoto et al. (2006) Comparative analysis on images of Cycle-Oriented Society. *Journal of the Japan Society of Waste Management Experts* 17(3), pp.204-218 (in Japanese)

# Review: Various similar terms and English translations

## Various terms similar to Junkan-Gata Society

廃棄物循環型社会  
 リサイクル社会  
 資源リサイクル社会  
 資源循環型社会  
 ゼロエミッション社会  
 廃棄物ゼロ・資源循環型社会  
**循環型社会**  
 持続可能な循環型社会  
 循環型経済社会  
 循環型社会経済システム  
 循環社会  
 環境保全型・資源循環型社会  
 省資源・環境保全型社会  
 循環型共生社会  
 環境共生型社会  
 低エントロピー社会

## English translations of Junkan-Gata Society

### Recycling society

Resource recycling society  
 Recycling-based society  
 Material-recycling-based society  
 Recycle-oriented society  
 Recycling-oriented society  
 Material cycles oriented society  
 Society with sound material cycles  
 Sound material-cycle society  
 Circulatory society  
 Circulating society  
 Closed loop society  
**Sustainable society**  
 Sustainable eco-society

## Brief history of Junkan-Gata Society

- ❑ 1990: A committee for **Junkan-Gata Socio-System** for Environmental Protection (Environment Agency)
  - Examined ideal socio-system for environmental protection (idea of **Junkan-Gata Socio-System**) according to the processes of production, distribution, consumption, disposal, and recovery, which are the cores of socio-economic activity
  
- ❑ 1994: The First Basic Environment Plan
  - Based on The Basic Environment Law (1993)
  - Established four long-term goals of environmental policy
    1. **Junkan (environmentally sound material cycle)**
    2. Harmonious coexistence
    3. Participation
    4. International activities



## Brief history of Junkan-Gata Society

- 
- ❑ 2000: The Fundamental Law for Establishing a **Junkan-Gata Society**
    - Aims at achieving “junkan,” one of the four long-term goals in the Basic Environment Plan, specifically proper material cycles in the human society, by focusing on measures for waste management and recycling, which are its emergent and central issue
    - Defined “**Junkan-Gata Society**” for the first time in the law

## Definition of Junkan-Gata Society

- 2000: By The Fundamental Law for Establishing a Junkan-Gata Society
  - “Junkan-gata society” is a society where **the consumption of natural resources is restrained and the environmental load is reduced as much as possible**, by restraining products, etc. from becoming wastes, etc., promoting appropriate **recycling** of products, etc. when they have become recyclable resources, and securing appropriate disposal of the recyclable resources not recycled
  - 「循環型社会」とは、製品等が廃棄物等となることが抑制され、・・・製品等が循環資源となった場合においては・・・適正に**循環的な利用**が行われることが促進され、・・・循環的な利用が行われない循環資源については適正な処分・・・が確保され、**もって天然資源の消費を抑制し、環境への負荷ができる限り低減される**社会をいう



## Definition of Junkan-Gata Society

- 1990: By Committee for Junkan-Gata Socio-System for Environmental Protection
- To achieve sustainable development, the way of economic activity that fits to **great cycles in ecosystems** must be designed and practiced..... (To this end,) it is necessary **to restrain the input of primary resources and to minimize the amount of emissions to natural ecosystem** by putting a higher priority on **reuse and recycling** than disposal, **and to prevent the emissions from disturbing the environment**. Such socio-economic system can be called “Junkan-Gata Society”
- 「持続可能な開発」を達成するには・・・**生態系の大循環**に適合するような経済活動の在り方を考え、具体化していかなければならない。・・・（このためには、）廃棄より**再使用・再生利用**を第一に考え、**新たな資源の投入をできるだけ押さえることや、自然生態系に戻す排出物の量を最小限とし、その質を環境を攪乱しないものとする**ことが必要である。こうした経済社会の在り方は「循環型社会」と呼ぶことができよう。

# Cycles in the environment and socio-economic system

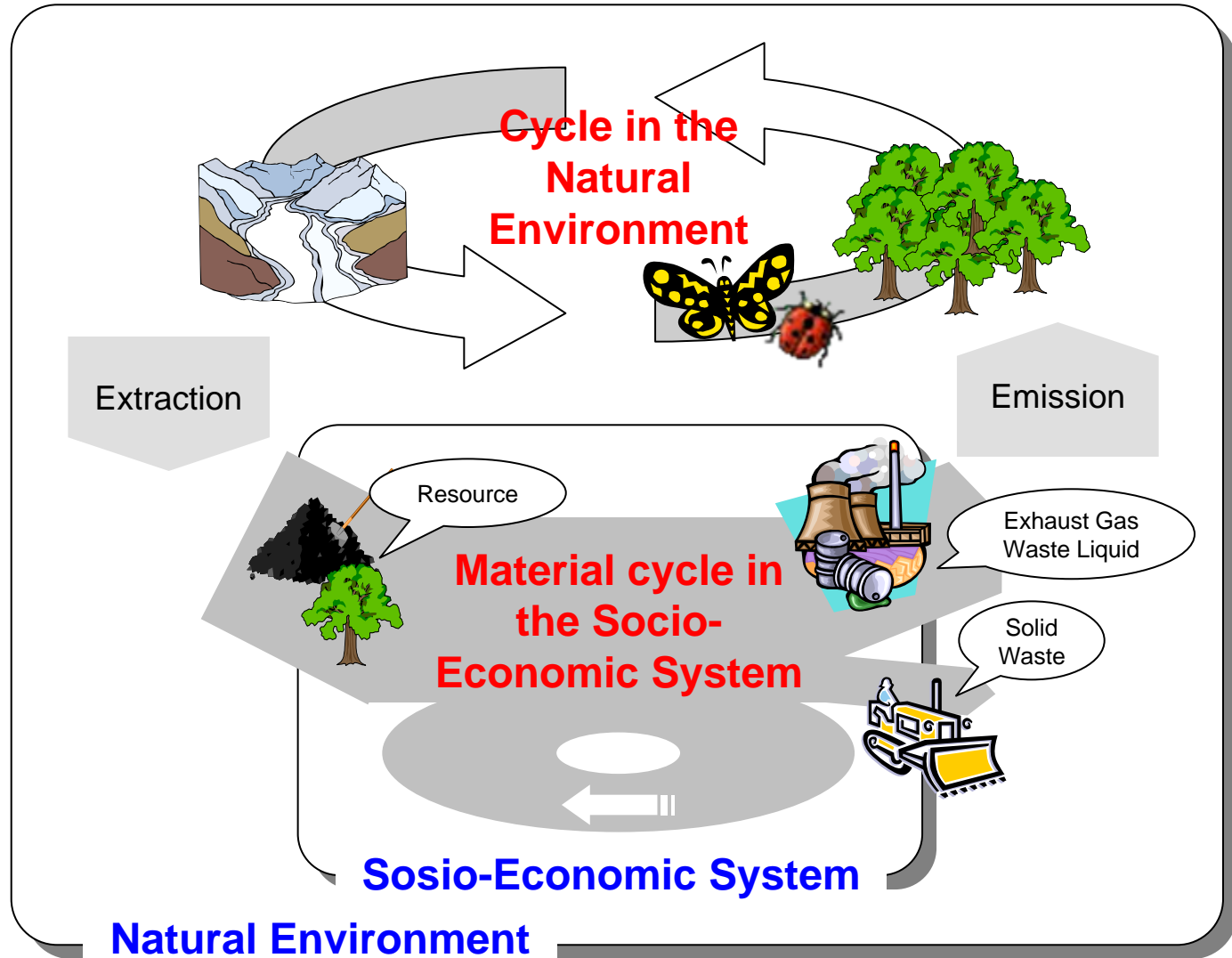

# Review: Concepts of Junkan

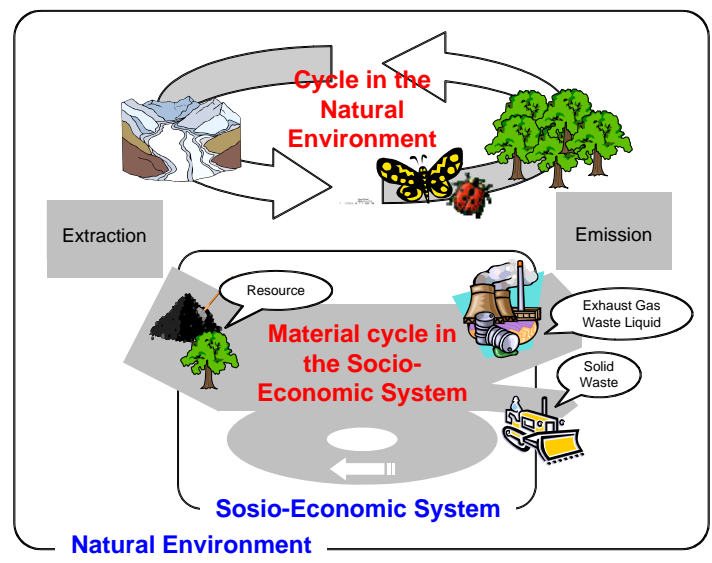

**Cycle in the Natural Environment**

Controlling resource extractions and environmental burdens to prevent cycles in ecosystem from being disturbed

**Cycle in the Socio-Economic System**

Reusing and recycling resources to the extent possible within society

**Virtuous Cycle of the Environment & Economy**

Integrating environmental protection and economic development

**Cycle of Relationships and Lives**

Understanding and building relationship between the nature and human beings and between persons, sharing information and promoting activities, valuing a human life and a thing's life, etc.

Edahiro J.  
 "Junkan is to connect thoughts"  
 "Samsara: transmigration of the soul"

Kitoh S.  
 "Network of relationships"  
 "Junkan of relationships"

Hanai Y.  
 "The basis of Junkan-Gata Society is junkan of people"

# Legislative framework

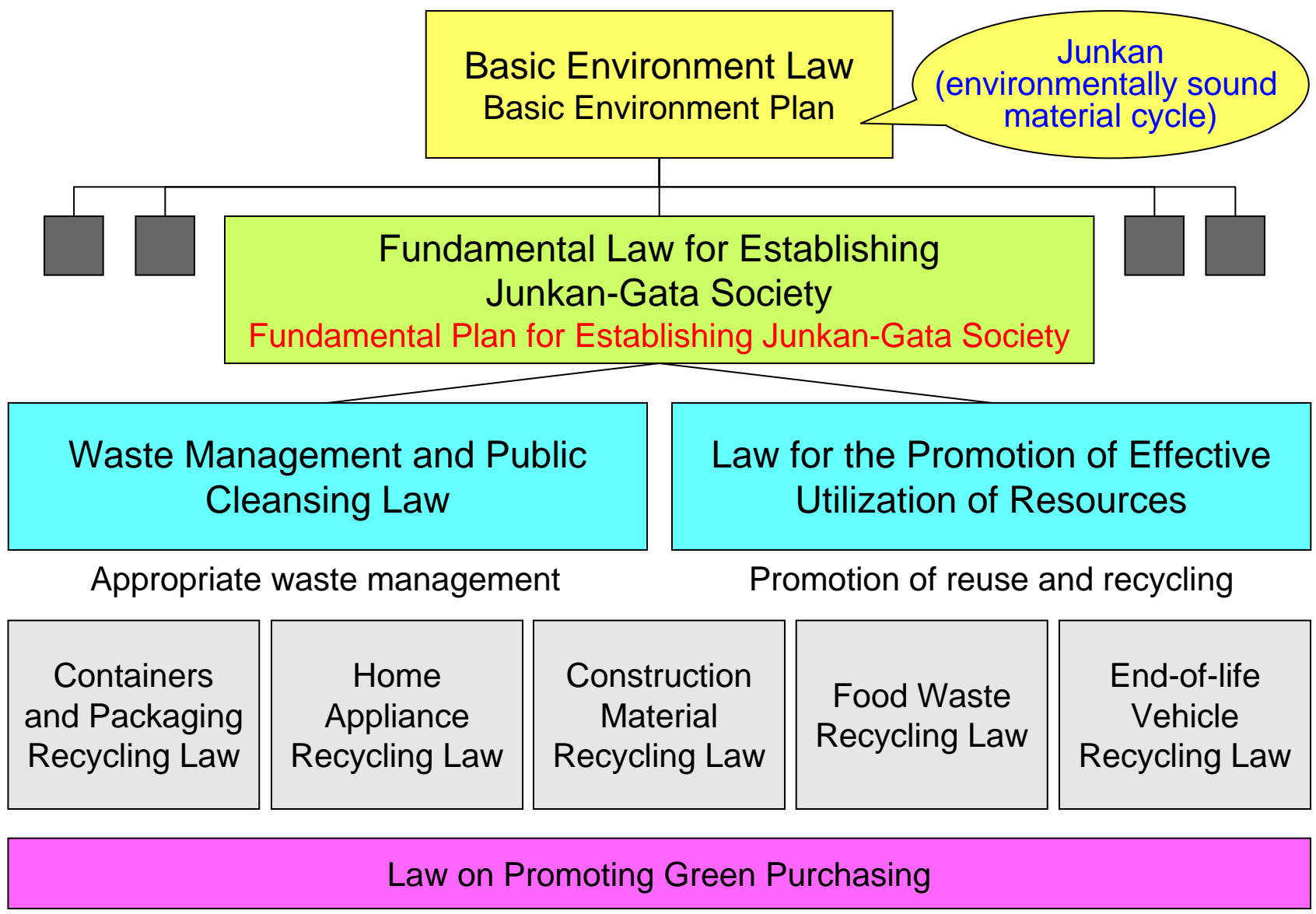

# Review: Various similar terms and English translations

## Various terms similar to Junkan-Gata Society

廃棄物循環型社会  
 リサイクル社会  
 資源リサイクル社会  
 資源循環型社会  
 ゼロエミッション社会  
 廃棄物ゼロ・資源循環型社会  
**循環型社会**  
 持続可能な循環型社会  
 循環型経済社会  
 循環型社会経済システム  
 循環社会  
 環境保全型・資源循環型社会  
 省資源・環境保全型社会  
 循環型共生社会  
 環境共生型社会  
 低エントロピー社会

## English translations of Junkan-Gata Society

### **Recycling society**

Resource recycling society  
 Recycling-based society  
 Material-recycling-based society  
 Recycle-oriented society  
 Recycling-oriented society  
 Material cycles oriented society  
 Society with sound material cycles  
**Sound material-cycle society**  
 Circulatory society  
 Circulating society  
 Closed loop society  
**Sustainable society**  
 Sustainable eco-society





# National material flow indicators and targets

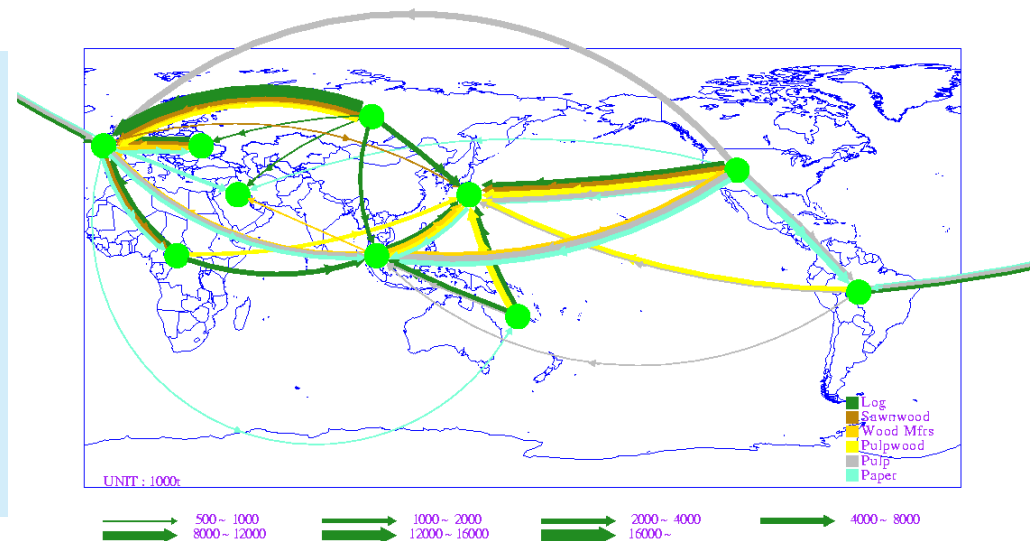

Source: Moriguchi and Hashimoto (2006) Material Flow Data Book - World Resource Flows around Japan - Third Edition (No. D040-2006) ([http://www-cger.nies.go.jp/cger-e/e\\_report/r\\_index-e.html#2006](http://www-cger.nies.go.jp/cger-e/e_report/r_index-e.html#2006))



# Material flows in Japan (fiscal 2000)

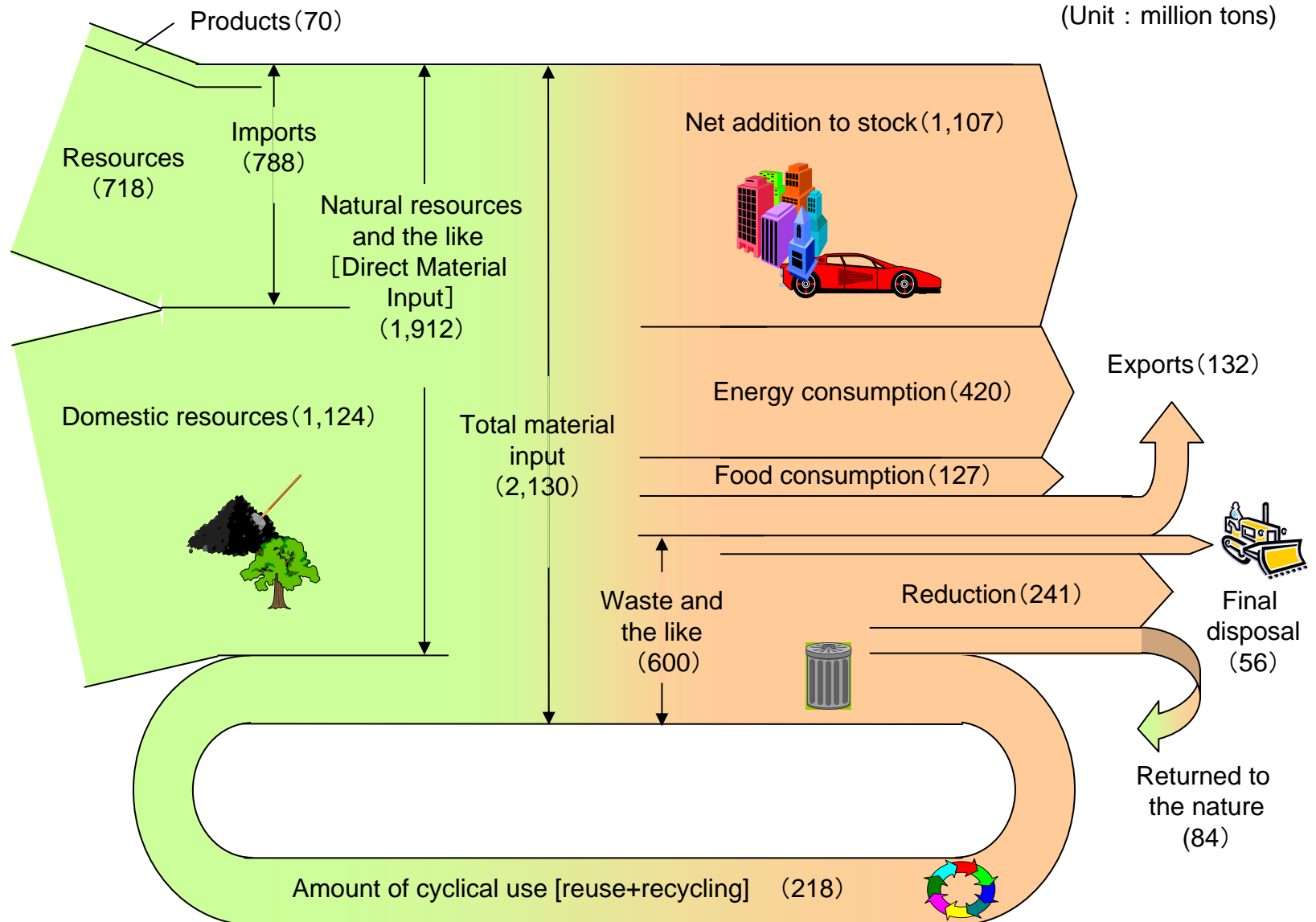

# MF indicators in The Fundamental Plan (2003 & 2008)

## Inflow

**GDP/DMI  
Resource  
Productivity**

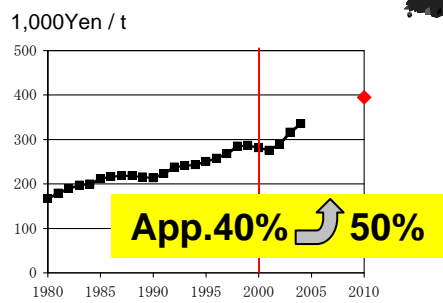

Direct Material Input (DMI)

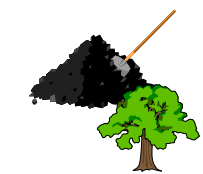

Net Additions to Stock

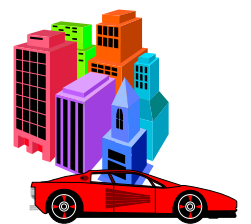

Export

Emissions to Air  
Emissions to Water



Final Disposal (FD)



Waste and the Like

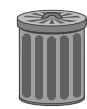

Returned to Nature

## Cyclical Flow

**CU/(DMI+CU)  
Cyclical Use Rate**

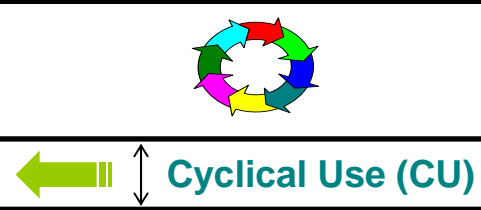
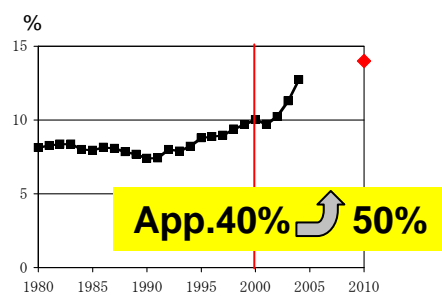

## Outflow

**FD  
Final  
Disposal  
Amount**

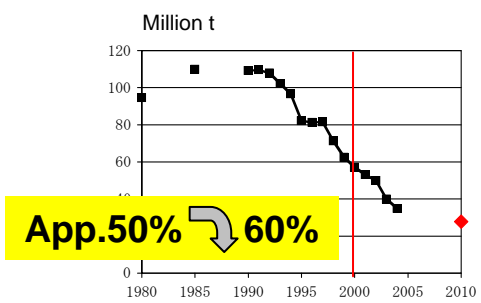

## Background

- ❑ 2000: The Fundamental Plan required by The Fundamental Law for Establishing a Junkan-Gata Society
- ❑ 2000: Quantitative target required by The Second Basic Environment Plan
  - For objective assessment of policies and measures implemented based on The Fundamental Plan
- ❑ 2002: Material flow indicators mentioned in the recommendation by The Central Environmental Council
  - For example, the amount of total material input, reuse rate, recovery rate, collection rate, and the amount of waste

# Background

- 19 candidates for indicators were examined based on the following required conditions of indicators
  - Appropriateness of the expression of target conditions or activities
  - Clarity and understandableness
  - Measurability and accuracy
  - Sensitivity to the results of policies and measures

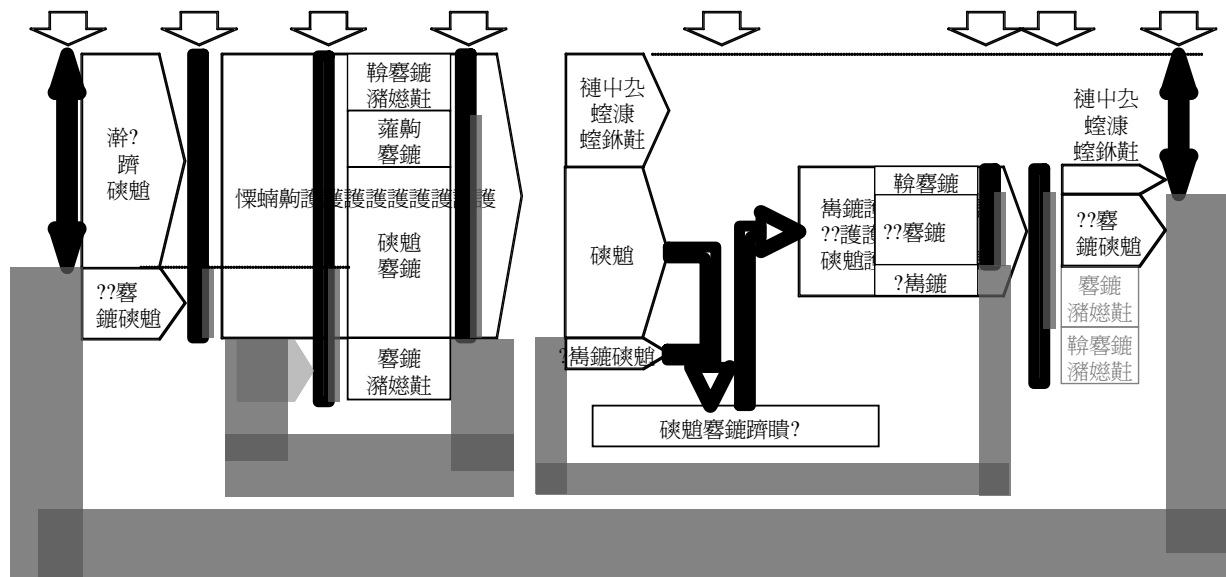



# Inflow indicator



Source: High Moon (1995) Gomic Haikibutsu, Vol.3, Nippo

# Inflow indicator

## ☐ Inputs = outputs

- Reduce the consumption of materials to reduce the emergence of waste

## ☐ Definition in The Fundamental Law

- "Junkan-gata society" is a society where **the consumption of natural resources is restrained** and the environmental load is reduced as much as possible

## ☐ Regulation of absolute amount of resource use

- To provide that "consumption of natural resources shall be under XX tons" was impossible both scientifically and politically

## ☐ Natural resource consumption

$$= \text{GDP} \times (\text{Natural resource consumption} / \text{GDP})$$

- Reduction of GDP cannot be agreed
- Inverse of "Natural resource consumption / GDP" was adopted



# Inflow indicator

## Resource Productivity

$$\frac{\text{GDP}}{\text{Direct Material Input (DMI)}} \quad (\text{yen} / \text{ton})$$

**Dematerialization**  
**More value-added**  
**with less materials**

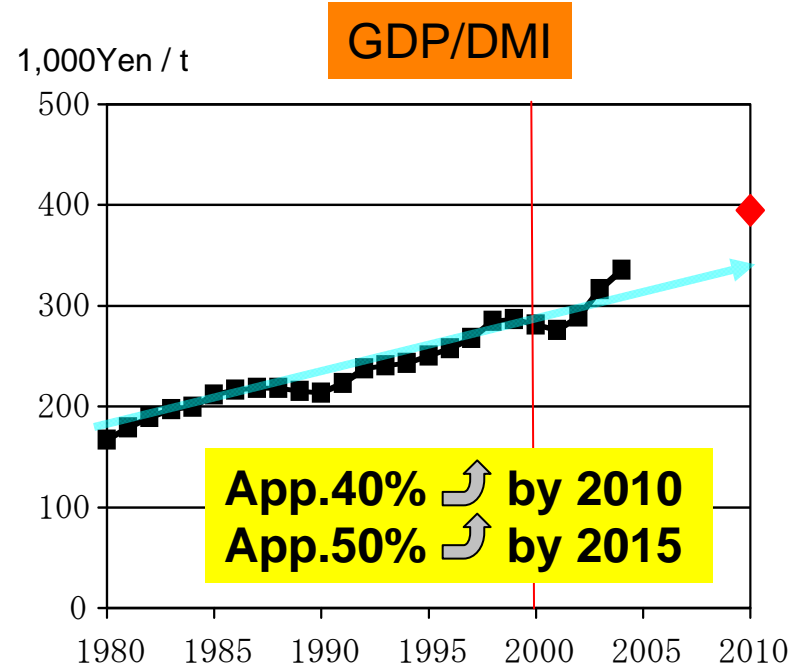
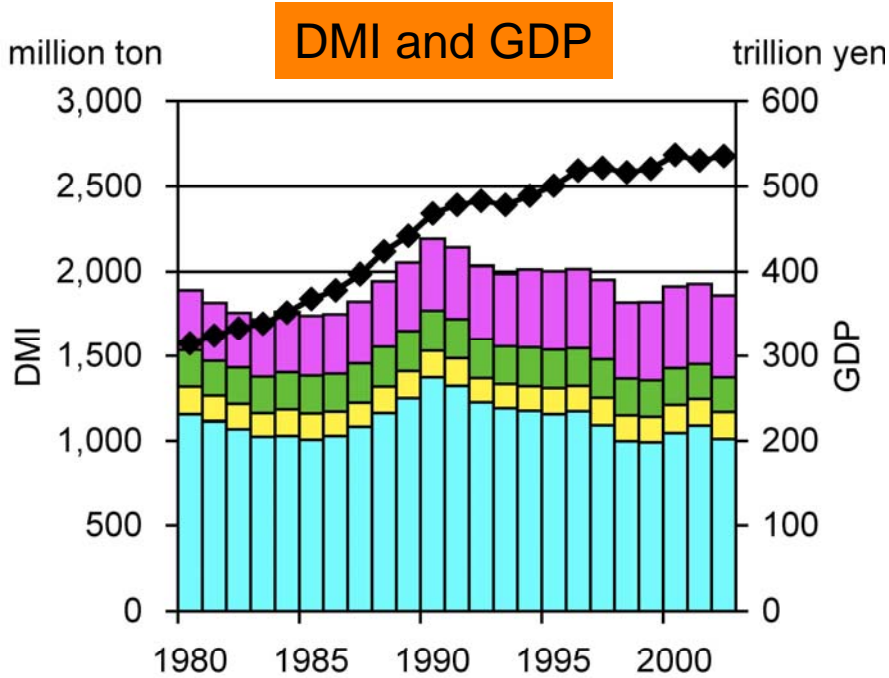

- Non-metallic minerals
- Metallic minerals
- Biomass
- Fossil fuels
- ◆ GDP

# Outflow indicator

## □ Definition in The Fundamental Law

- "Junkan-gata society" is a society where the consumption of natural resources is restrained and **the environmental load is reduced** as much as possible

## □ CO<sub>2</sub> is the biggest emissions to the environment

- CO<sub>2</sub> is regulated by Kyoto Protocol
- Other environmental pollutants are regulated by other schemes

## □ Limit of landfill capacity

- Number of remaining years of landfill sites  
Municipal solid waste: 12.5 years (fiscal 2001)  
Industrial solid waste: 4.3 years (fiscal 2001)

Remaining capacity of landfill sites at the end of the fiscal year (volume)  
Waste disposed of in the fiscal year (volume/year)

# Outflow indicator

## Final disposal amount

Final disposal amount (million ton)

**Reduction of final disposal amount is directly related to current waste problem in Japan**

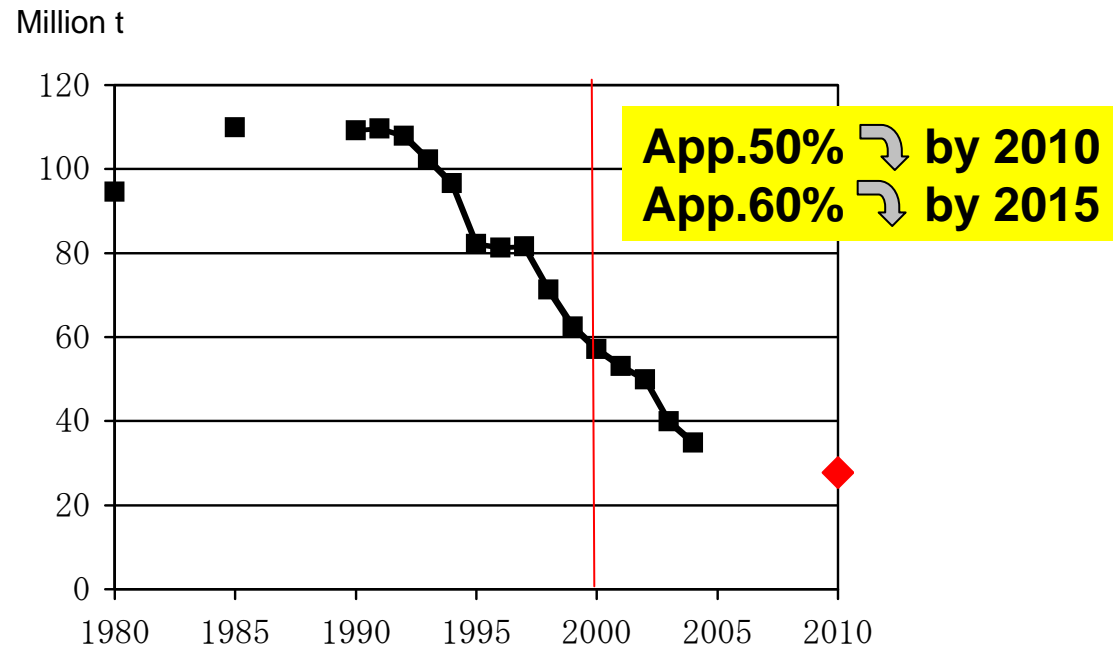

# Cyclical flow indicator

## □ Output side vs input side

- $\frac{\text{Reuse and recycling}}{\text{Waste output}}$  vs  $\frac{\text{Reuse and recycling}}{\text{Material input}}$
- Output side indicator represents the reduction efficiency of waste emissions to the environment
- Input side indicator represents the reduction efficiency of primary resources including energy use for recycling

## □ Measurement issue

- Theoretical measurement problem, which is similar to “length-of-coastline problem.”
- Eurostat Guide (2001): “the definition and measurement of recycling flows is difficult” Not recommend to make recycling accounts part of a standard set of economy-wide MFA at present.
- Japan’s case: List up what we regard as reuse and recycling  
e.g. reuse: only reused returnable bottles included  
recycling: recycled livestock excrement and urine excluded

# Cyclical flow indicator

## Cyclical use rate

$$\frac{\text{Cyclical use (reuse and recycling)}}{\text{Cyclical use (reuse and recycling) + Direct Material Input (DMI)}}$$

**Substitution of reused and recycled materials for primary resources**

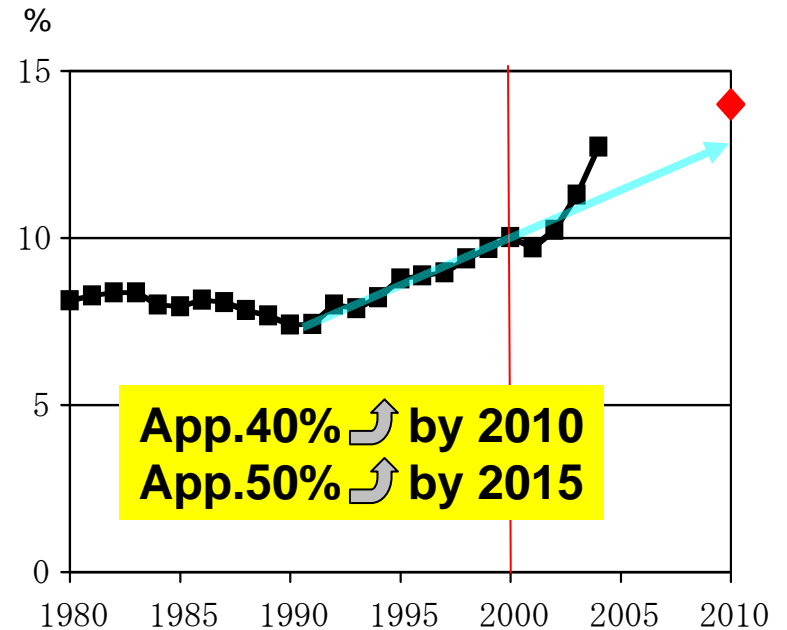
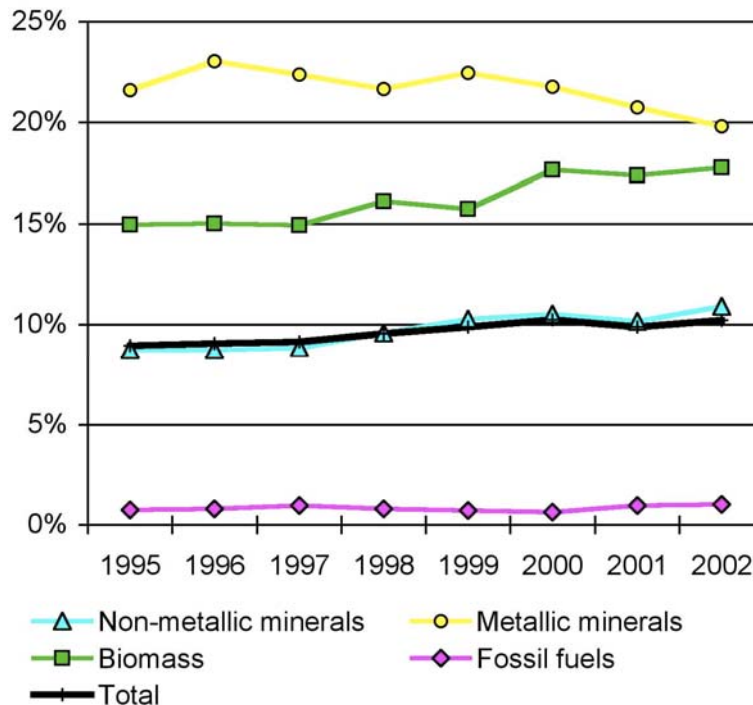



# Problems associated with material flows

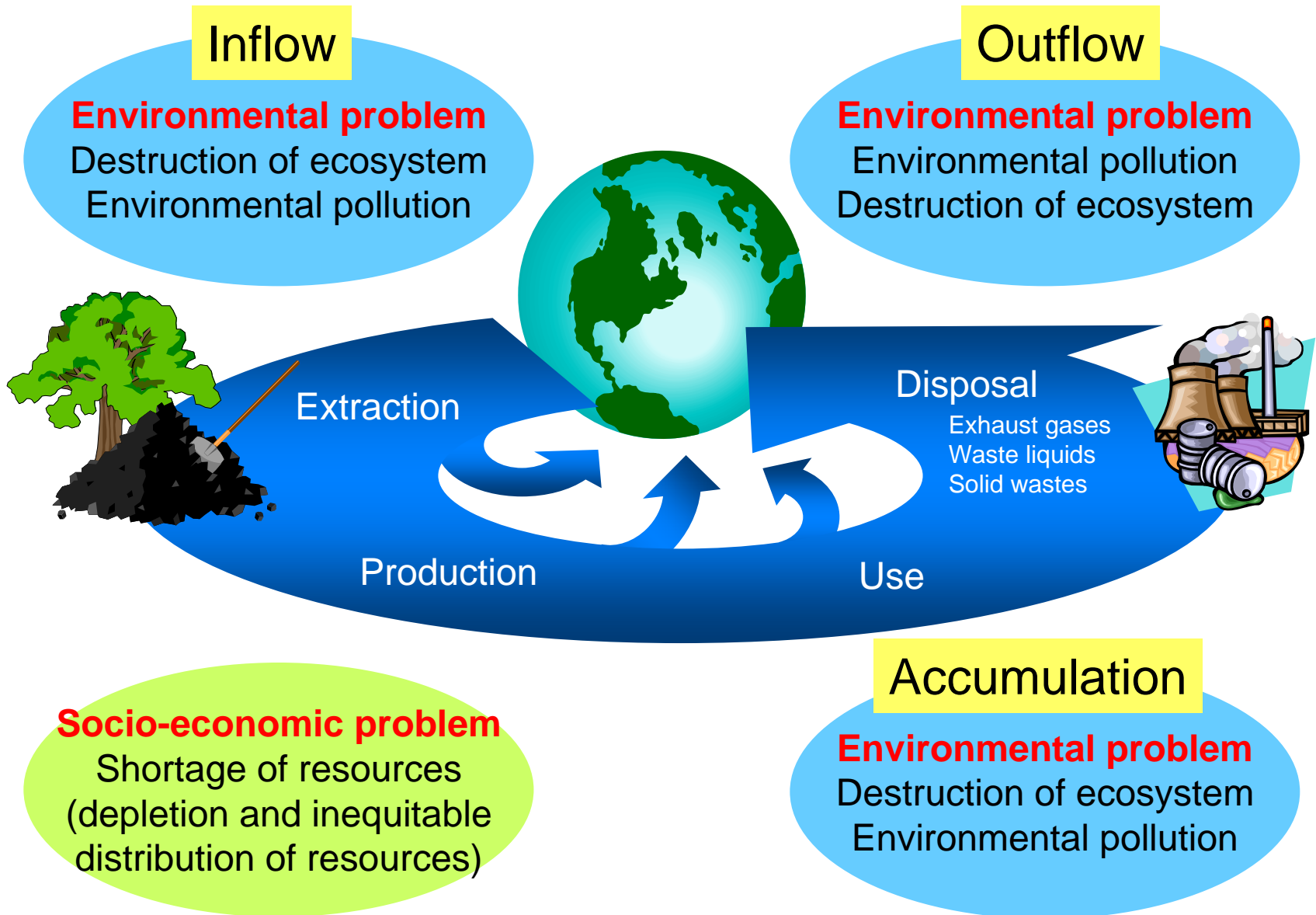



# Discussions regarding national MF indicators

## Inflow

GDP/DMI  
Resource  
Productivity

## Viewpoint of indicating environmental problems



- **Is simple summation of weight of materials appropriate?.....①**
  - ✓ Weights of stones and gravels have great impact on the total.
  - ✓ Light but hazardous materials are underestimated.
  - ✓ Renewables and non-renewables are equally treated.
  - ✓ Absolute amount is not linked with ecosystem carrying capacity.

# Discussions regarding national MF indicators

## Inflow

GDP/DMI  
Resource  
Productivity

## Viewpoint of indicating environmental problems

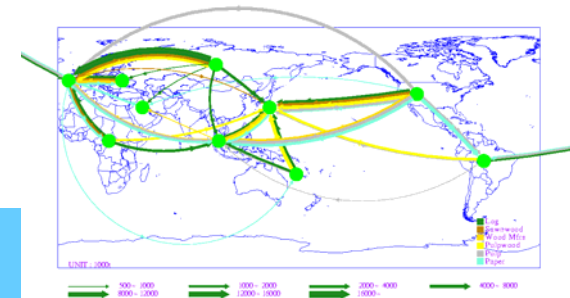

- **How should environmental problems associated with resource extraction be considered?.....②**

  - ✓ Hidden flows or concrete environmental problems should be measured.
  
- **How should transfer of environmental problems through international trade be measured and interpreted?.....③**

  - ✓ Environmental problems are transferred to other countries through international trade.
  - ✓ DMI could be underestimated because of increased import of processed goods.

# Discussions regarding national MF indicators

## Inflow

GDP/DMI  
Resource  
Productivity

Viewpoint of indicating socio-economic problems



### ■ Is simple summation of weight of materials appropriate?.....①

- ✓ Weights of stones and gravels have great impact on the total.
- ✓ Light but rare materials are underestimated.
- ✓ Renewables and non-renewables are equally treated.
- ✓ Absolute amount is not linked with reserves of resources.

# Discussions regarding national MF indicators

## Inflow

GDP/DMI  
Resource  
Productivity

## Cyclical Flow

$CU/(DMI+CU)$   
Cyclical Use Rate

## Outflow

FD  
Final  
Disposal  
Amount



## Viewpoint of promoting responses to the problems

- **How should individual effort be assessed and connected to national MF indicators?.....④**
  - ✓ Connection between individual effort and macro MF indicators should be structured.
  - ✓ Indicators for individual item and entity based on a common methodology are necessary.
- **How should stocked materials as potential wastes and secondary resources be managed?.....⑤**
  - ✓ Management of materials accumulated in the society will be important in the future.

# Discussions regarding national MF indicators

## Inflow

GDP/DMI  
Resource  
Productivity

## Cyclical Flow

$CU/(DMI+CU)$   
Cyclical Use Rate

## Outflow

FD  
Final  
Disposal  
Amount



## Viewpoint of promoting responses to the problems

- **How should transfer of environmental problems through international trade be measured and interpreted?.....③**
  - ✓ How should export of recyclables be assessed in establishing a Junkan-Gata Society?
  - ✓ Export of recyclables decreases cyclical use rate.
- **How can MF information be improved?**
  - ✓ Trade of recyclables need to be captured accurately.
  - ✓ Prompt report of MF data is required.
  - ✓ Future MF should be estimated.



## Our current view and status

- **Is simple summation of weight of materials appropriate?.....①**
  - There are still many methodological issues regarding weighting different materials.
  - Justification in the Fundamental Plan
    - Weight is mainly used in the field of waste management and input materials are all potential wastes in the future.
    - Individual material is covered by effort indicators (targets by industry, good, and waste).
  - Several supplementary indicators were introduced in the 2nd Fundamental Plan (2008)
    - Resource productivity which excludes non-metallic minerals (stones and gravels)
    - Biomass resource input ratio

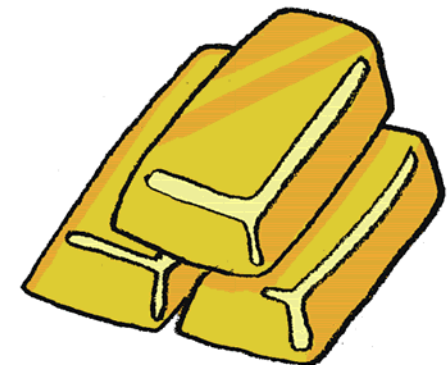



## Our current view and status

- **How should environmental problems associated with resource extraction be considered?.....②**
- **How should transfer of environmental problems through international trade be measured and interpreted?.....③**
  - Estimation of hidden and indirect flows are planned in the 2nd Fundamental Plan (2008)
  - Estimation of trade flows of recyclable resources are planned in the 2nd Fundamental Plan (2008) Appropriate management scheme of traded recyclable resources is under discussion.
- **How should individual effort be assessed and connected to macro MF indicators?.....④**
  - Macro MF are now divided into 4 material categories (non-metallic minerals, metallic minerals, biomass, and fossil fuels).
  - Connection between individual effort and macro MF indicators need to be structured.
  - Common methodology is required for estimating and indicating 3R.

## Our current view and status

- **How should stocked materials as potential wastes and secondary resources be managed?.....⑤**
  - Basic information is required. Stocks are considered potential wastes and secondary resources, but not all stocked materials become wastes and secondary resources.





# MFA for Construction Minerals



This section is partly based on Hashimoto et al. (2007) Where will the large amounts of materials accumulated within the economy go? - A material flow analysis of construction minerals. *Waste Management* 27(12), 1725-1738

# Background: Material flows in Japan

Year: 2000  
Unit: Million tonnes

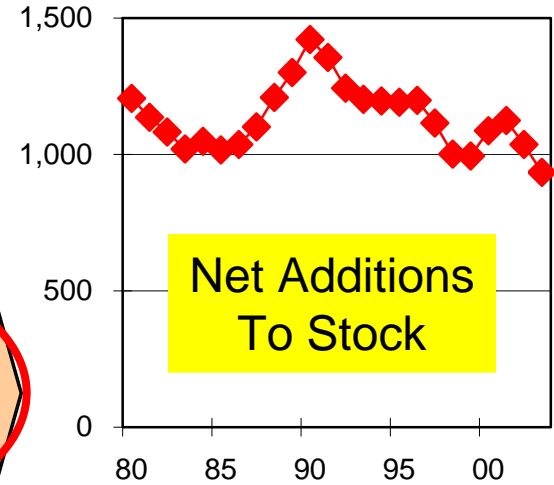
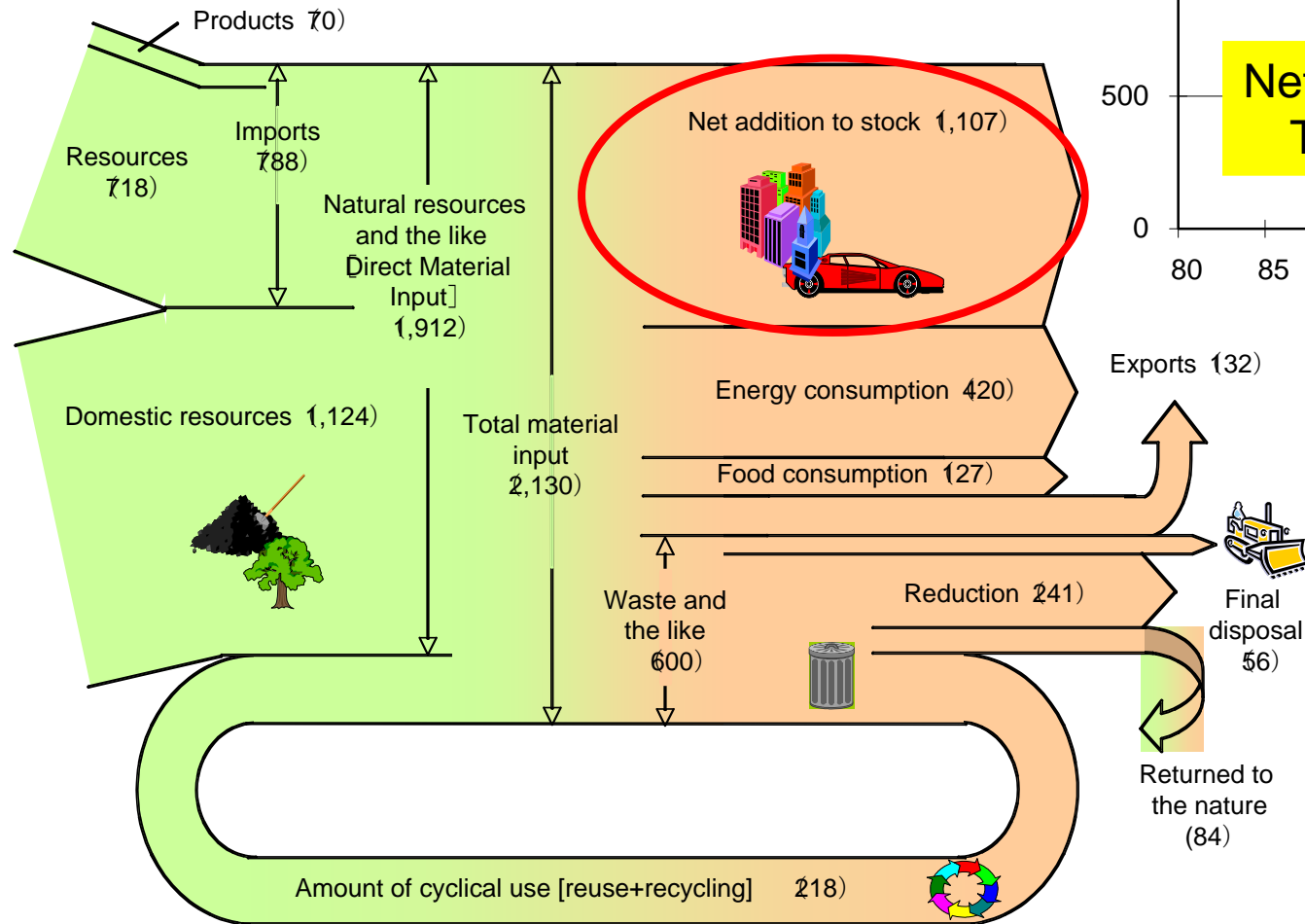



# Background: Meaning of NAS

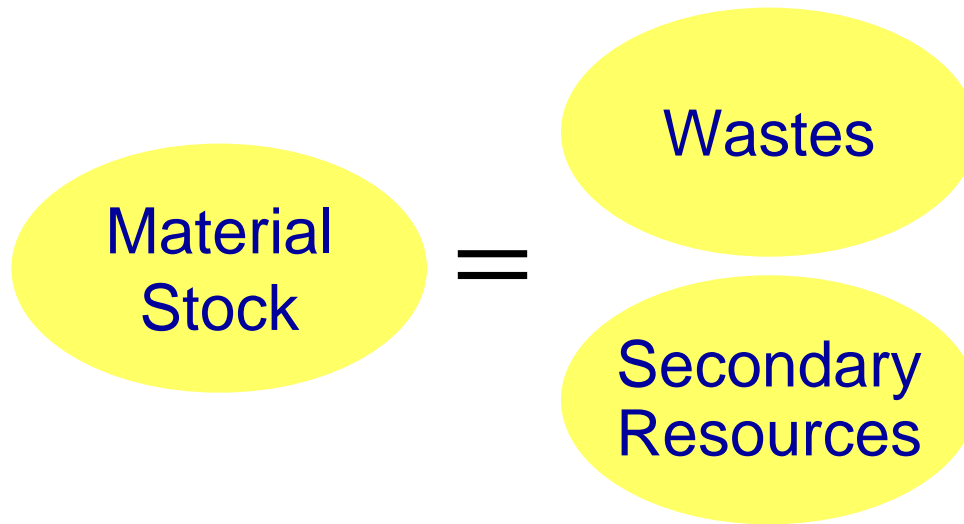

For proper disposal and reutilization of wastes in the future, it is important to accurately estimate the amount of accumulated materials that will emerge as wastes or secondary resources.



# Objectives

Refer to materials that have a high probability of emerging as wastes in the future as **potential wastes**



Estimate the amount of **potential wastes** for construction minerals in Japan as a case study

## Construction minerals

- ✓ Nearly half of total Japanese input materials
- ✓ Associated wastes less than a tenth of that amount



- ✓ Representative materials that accumulate as potential wastes (or as non-potential wastes)

Asphalt  
Cement  
Sand  
Gravel  
(Crushed) Stone

# Framework: Classification of materials

Potential wastes

Materials that have a high probability of emerging as wastes or secondary resources after use



e.g. building, asphalt concrete layer

Potential dissipated materials

Materials that have a low probability of emerging as wastes or secondary resources because they are dissipated during use or after use



e.g. crushed concrete, water pipe, pipe pile

Dissipatively used materials

Materials that have a primarily dissipative form of use (but that are not included in the "dissipative use" in EW-MFA)



e.g. roadbed, land development

Permanent structures

Materials that have a low probability of being expired



e.g. tunnel, dam, hill slope stabilization

# Estimated demand for construction minerals

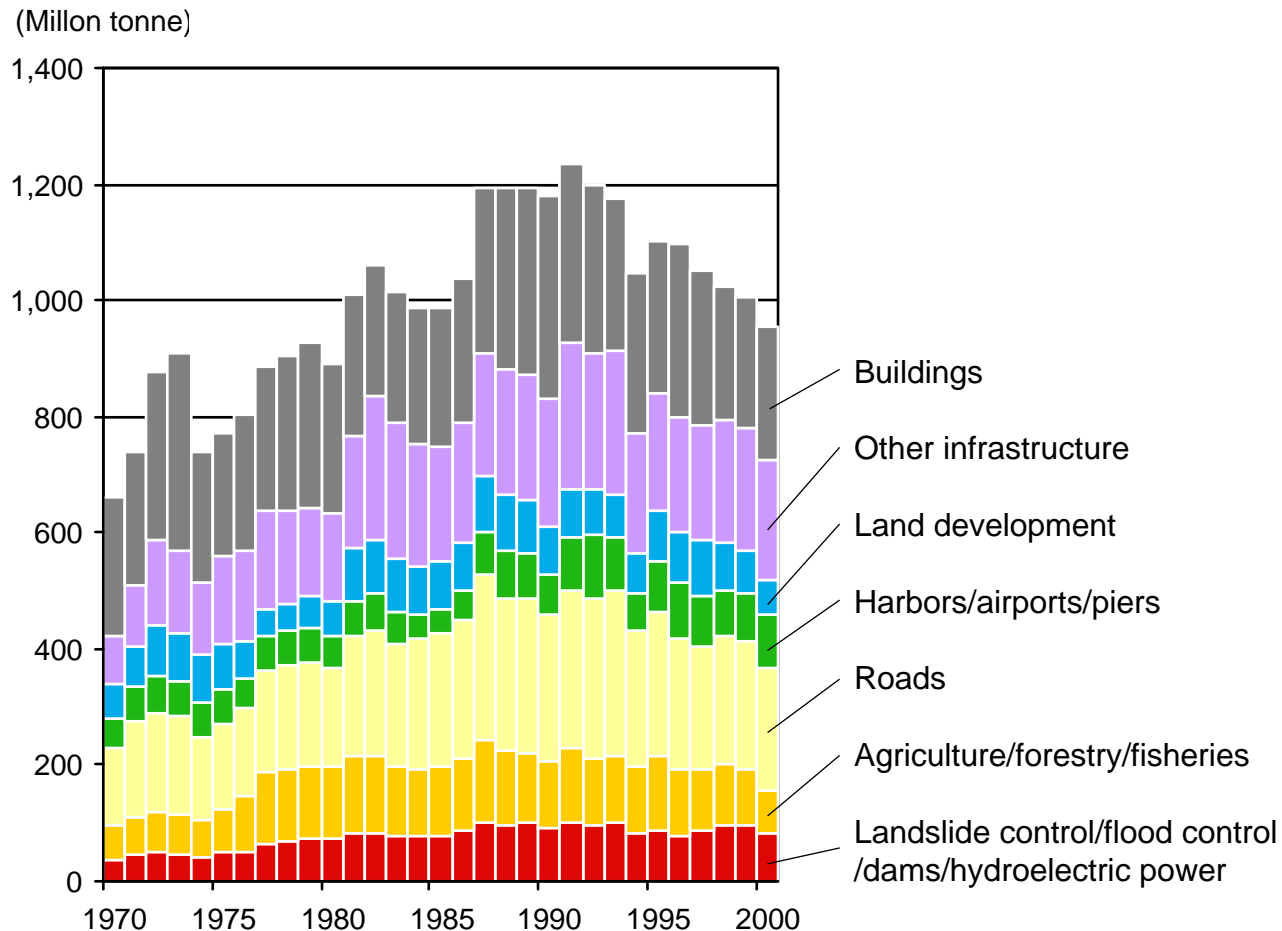

- Share of buildings has been about 25 – 30%
- Infrastructure mainly includes roads (20%), agriculture/forestry/fisheries, landslide/flood control, harbors/airports, and land development

# Determination of ratios: Buildings

## Construction minerals used for buildings

### Application

- Concrete structure Superstructure
- Foundation piles
- Subsurface structure
- Ground leveling



### Classification

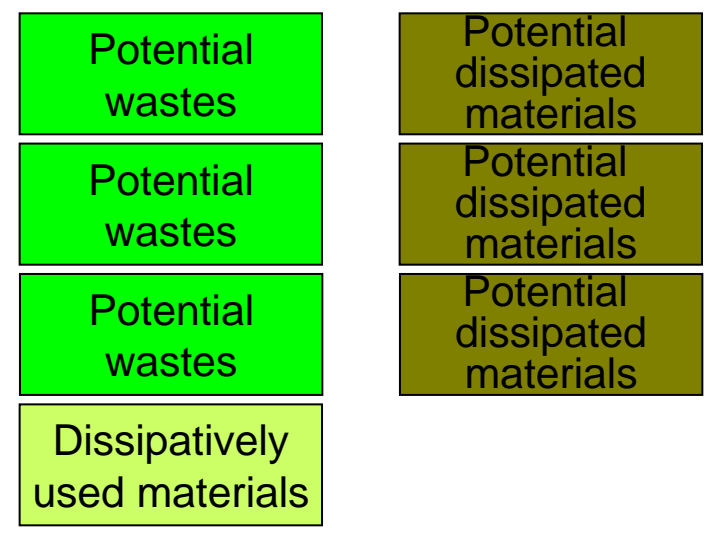



# Determination of ratios: Buildings

State of construction minerals brought into building construction site

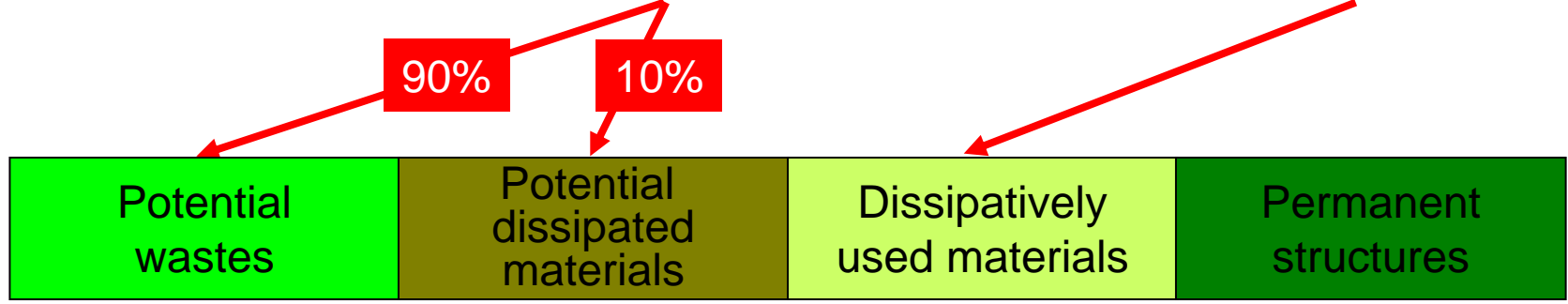
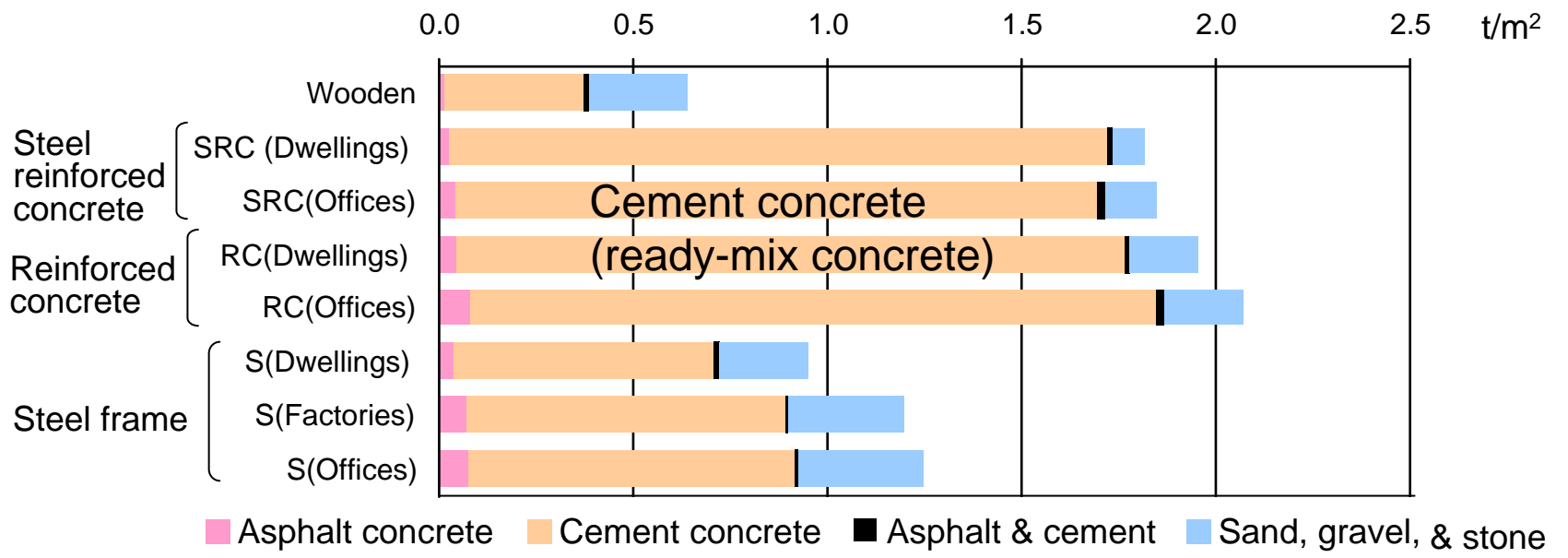



# Estimated potential and non-potential wastes

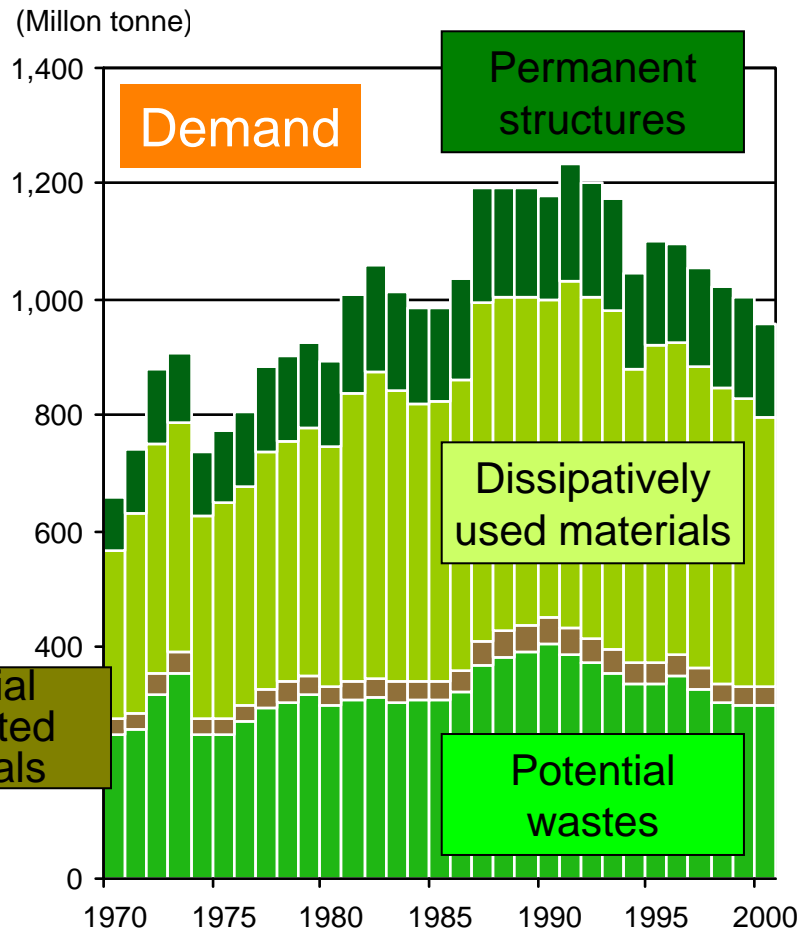

- Proportion of potential wastes was estimated to be about 30 – 40%
- 200 – 400 million tonnes were estimated to be annually input to Japanese economy as potential wastes

# Estimation method for waste generation

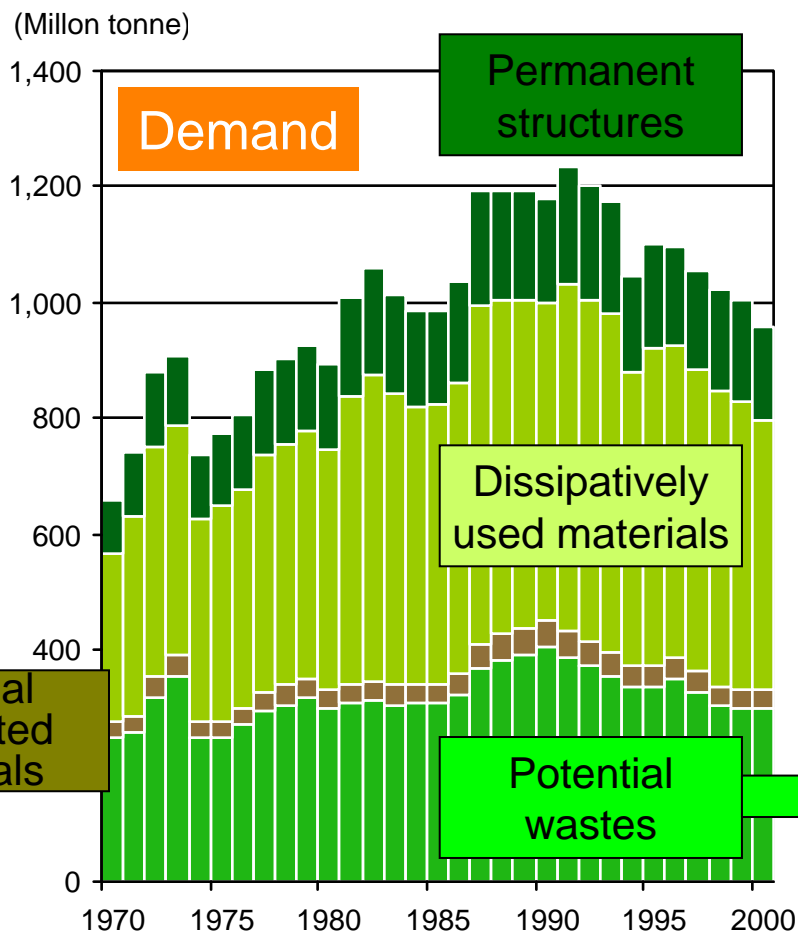

## For buildings:

- ✓ Physical data are available for floor space of construction and stock
- ✓ Estimated floor space of demolition  $\times$  potential waste input per floor space
- ✓ 8 types of buildings



## For infrastructure

- ✓ Dynamic modeling was applied (potential waste input and lifetime)
- ✓ 20 types of infrastructure

# Estimated generation and dissipation of wastes

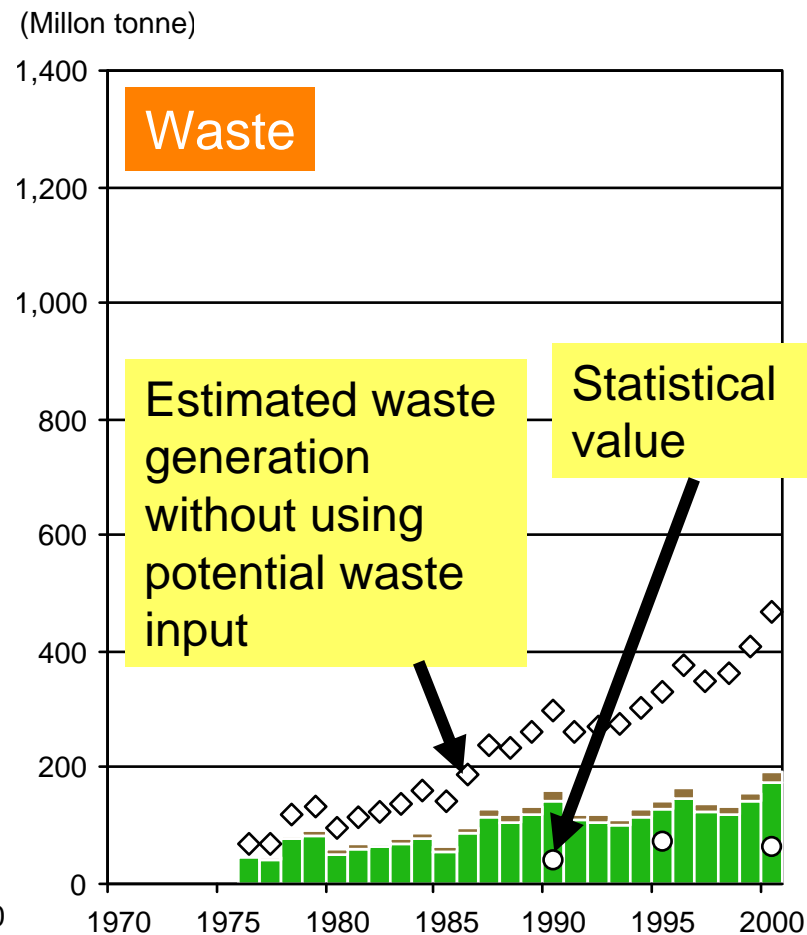
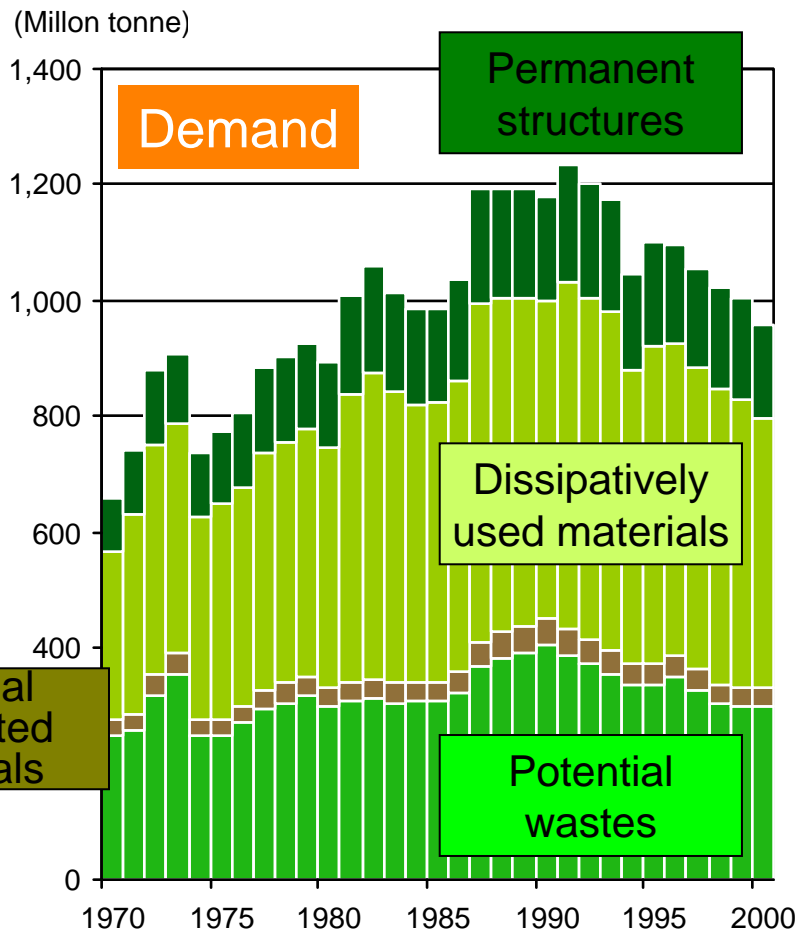

- ❑ Estimated amount of waste generation approached the reported statistical values
- ❑ Estimated waste generation and statistical data value do not necessarily correspond to each other

# Classification of stocked materials

	Identified resources		Undiscovered resources			Products		Wastes in managed landfill sites	Dissipated resources or substances	
	Demonstrated		Inferred	Probability range (or)		Emerging in a year	Not emerging in a year			
	Measured	Indicated		Hypothetical						Speculative
Economic	Reserves		Inferred reserves		Economic	Secondary reserves in a year	Secondary reserves in future			
Marginally economic	Marginal reserves		Inferred marginal reserves		Marginally economic	Marginal secondary reserves in a year	Marginal secondary reserves in future			
Subeconomic	Demonstrated subeconomic resources		Inferred subeconomic resources		Subeconomic (technologically feasible)	Subeconomic secondary resources in a year	Subeconomic secondary resources in future	Subeconomic secondary resources	Subeconomic secondary resources	
Other occurrences	Includes nonconventional and low-grade materials				Other (technologically infeasible)	Unrecoverable materials	Unrecoverable materials	Unrecoverable materials	Unrecoverable materials	

This section is based on Hashimoto et al. (2008) Framework of Material Stock Accounts – toward assessment of material accumulation in the economic sphere. *Proceedings of 8th International Conference on EcoBalance*, in press, 2008

# Objectives

- ❑ Develop a framework of Material Stock Accounts (MSA) through review of existing frameworks of MFA from the viewpoint of capturing material stocks
- ✓ Investigate types of material stocks,  
based on the frameworks such as  
Economy-Wide Material Flow Accounts (EW-MFA) and  
Integrated Environmental and Economic Accounts (SEEA),
- ✓ Discuss the purposes and significances of understanding material stocks after resource extraction, and
- ✓ Propose classifications of material stocks for waste management and resource reutilization  

The classification for resource reutilization is consistent with the classification for natural mineral resources: it will be useful to understand primary and secondary material stocks comprehensively as resources.



# Types of material stocks

cf. EW-MFA: Economy-Wide Material Flow Accounts  
 SEEA: Integrated Environmental and Economic Accounts

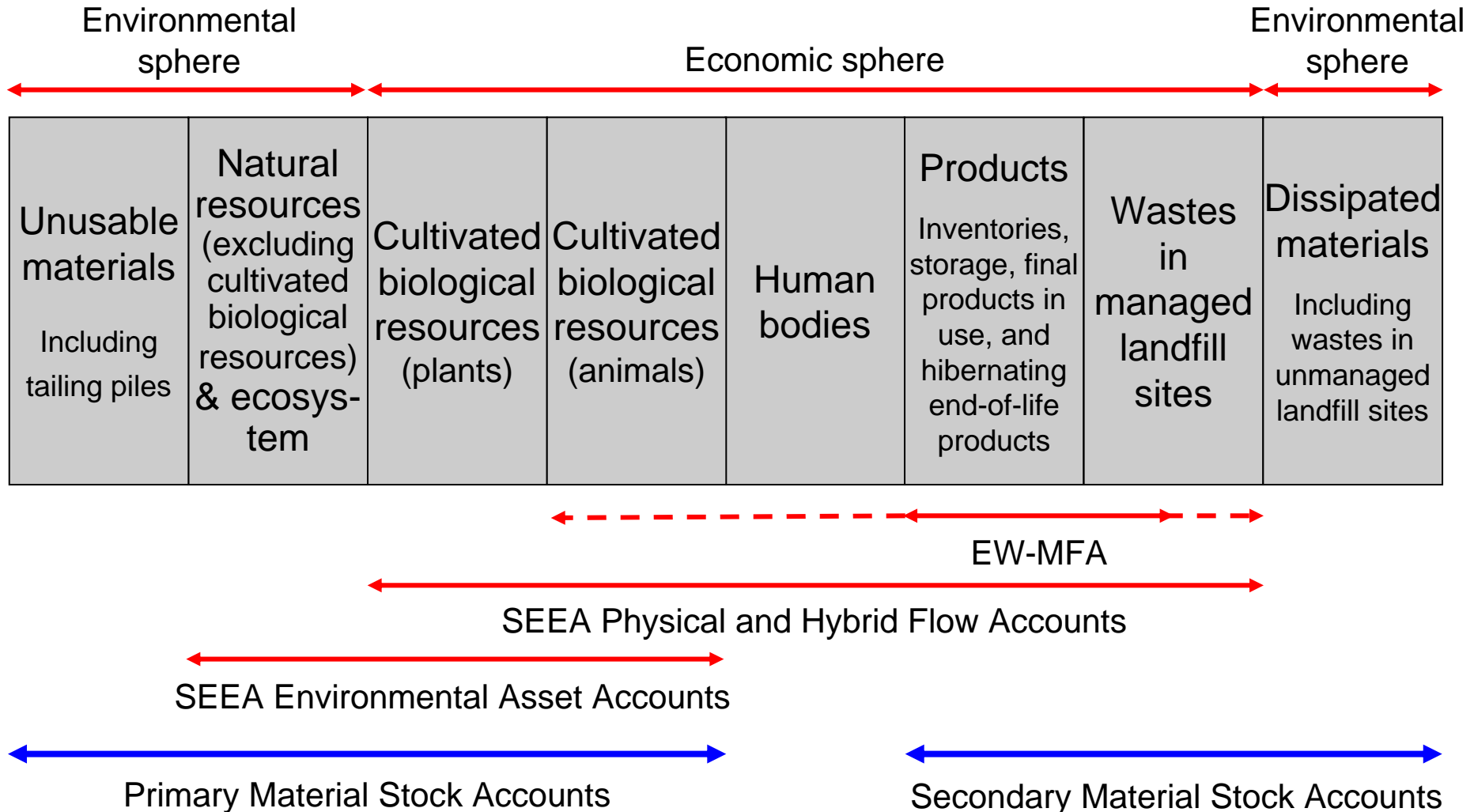

## Purposes and significances of understanding material stocks

- 
- Based on literature review, the purposes and significances of understanding material stocks includes:
    - Its use for **future waste management and resource reutilization**;
    - Its use for **more accurate understanding of material metabolism** in our economic society by capturing the amounts of stocks and **examining consistencies between the amounts of stocks and flows**.
  - ✓ More accurate understanding in the latter purpose serves the former purpose, i.e., more precise estimation of future wastes and reusable resources.
  - ✓ If any materials appearing to be discharged into the environment or exported to other countries exist, they might provide the basic information for considering the environmental impacts and loss of resources resulting from such materials.

# Classification of secondary material stocks

## Viewpoints for classification of secondary material stocks

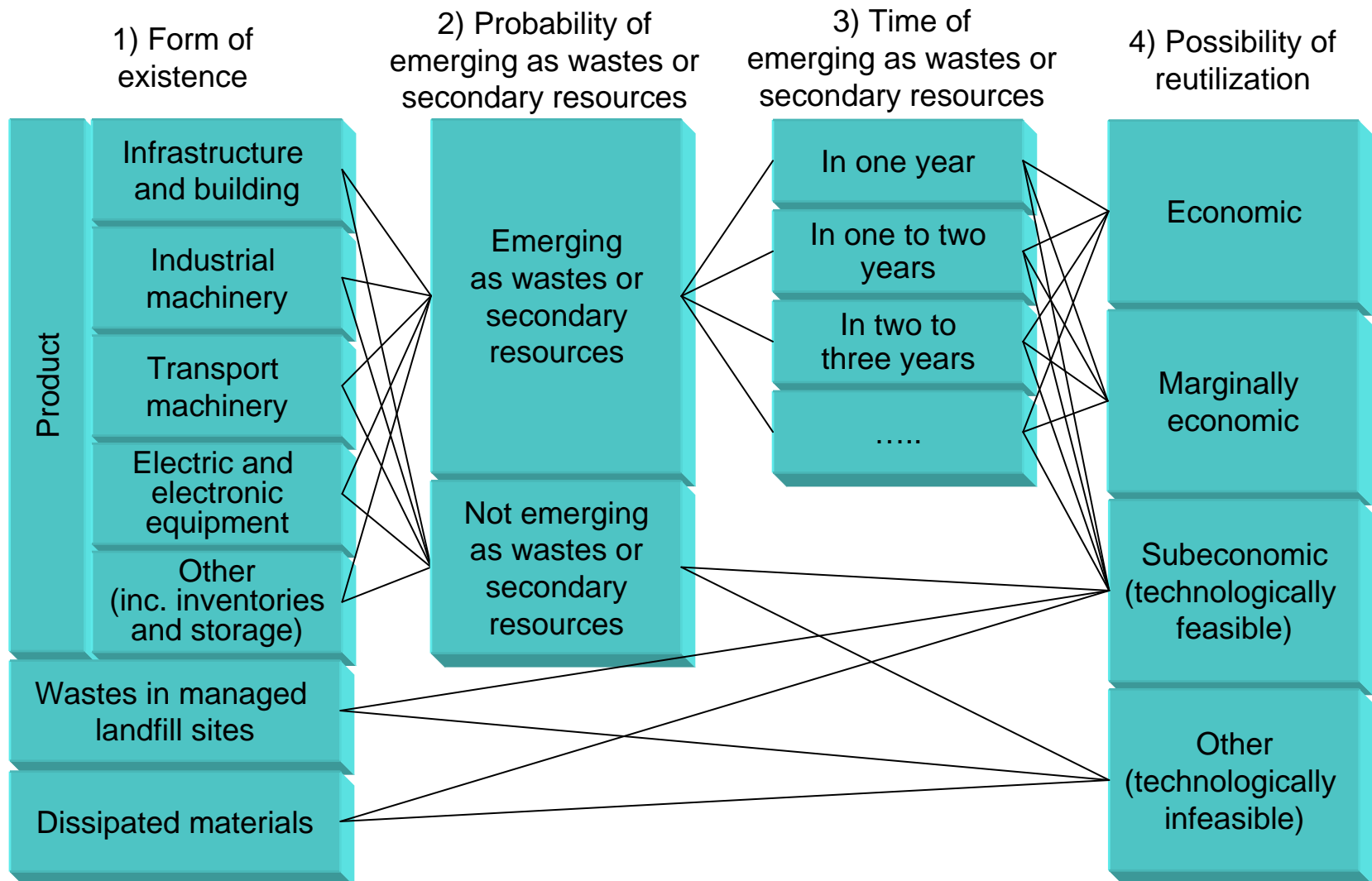

# Classification of secondary material stocks

## Materials not emerging as wastes or secondary resources

### Potential dissipated materials

Materials that are dissipated during use or after use

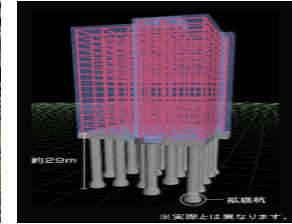

e.g. crushed concrete, water pipe, pipe pile

### Dissipatively used materials

Materials that have a primarily dissipative form of use



e.g. roadbed, land development

### Permanent structures

Materials that have a low probability of being expired



e.g. tunnel, dam, hill slope stabilization



# Classification of secondary material stocks

## Classification of products for waste management

3) Time of emerging as wastes or secondary resources

1) Forms of existence  
2) Probability of emerging as wastes or secondary resources

		Products	
		Emerging in a year	Not emerging in a year
Infrastructure and building	Emerging	Emerging in a year	Emerging in future
	Not emerging		Not emerging
Industrial machinery	Emerging	Emerging in a year	Emerging in future
	Not emerging		Not emerging
Transport machinery	Emerging	Emerging in a year	Emerging in future
	Not emerging		Not emerging
Electric and electronic equipment	Emerging	Emerging in a year	Emerging in future
	Not emerging		Not emerging
Other (inc. inventories and storages)	Emerging	Emerging in a year	Emerging in future
	Not emerging		Not emerging



# Classification of secondary material stocks

## Classification of secondary material stocks for resource reutilization

3) Time of emerging as wastes or secondary resources

	Products		Wastes in managed landfill sites	Dissipated materials
	Emerging in a year	Not emerging in a year		
Economic	Secondary reserves in a year	Secondary reserves in future		
Marginally economic	Marginal secondary reserves in a year	Marginal secondary reserves in future		
Subeconomic (technologically feasible)	Subeconomic secondary resources in a year	Subeconomic secondary resources in future	Subeconomic secondary resources	Subeconomic secondary resources
Other (technologically infeasible)	Unrecoverable materials	Unrecoverable materials	Unrecoverable materials	Unrecoverable materials

4) Possibility of reutilization

# Classification of secondary material stocks

## McKelvey diagram

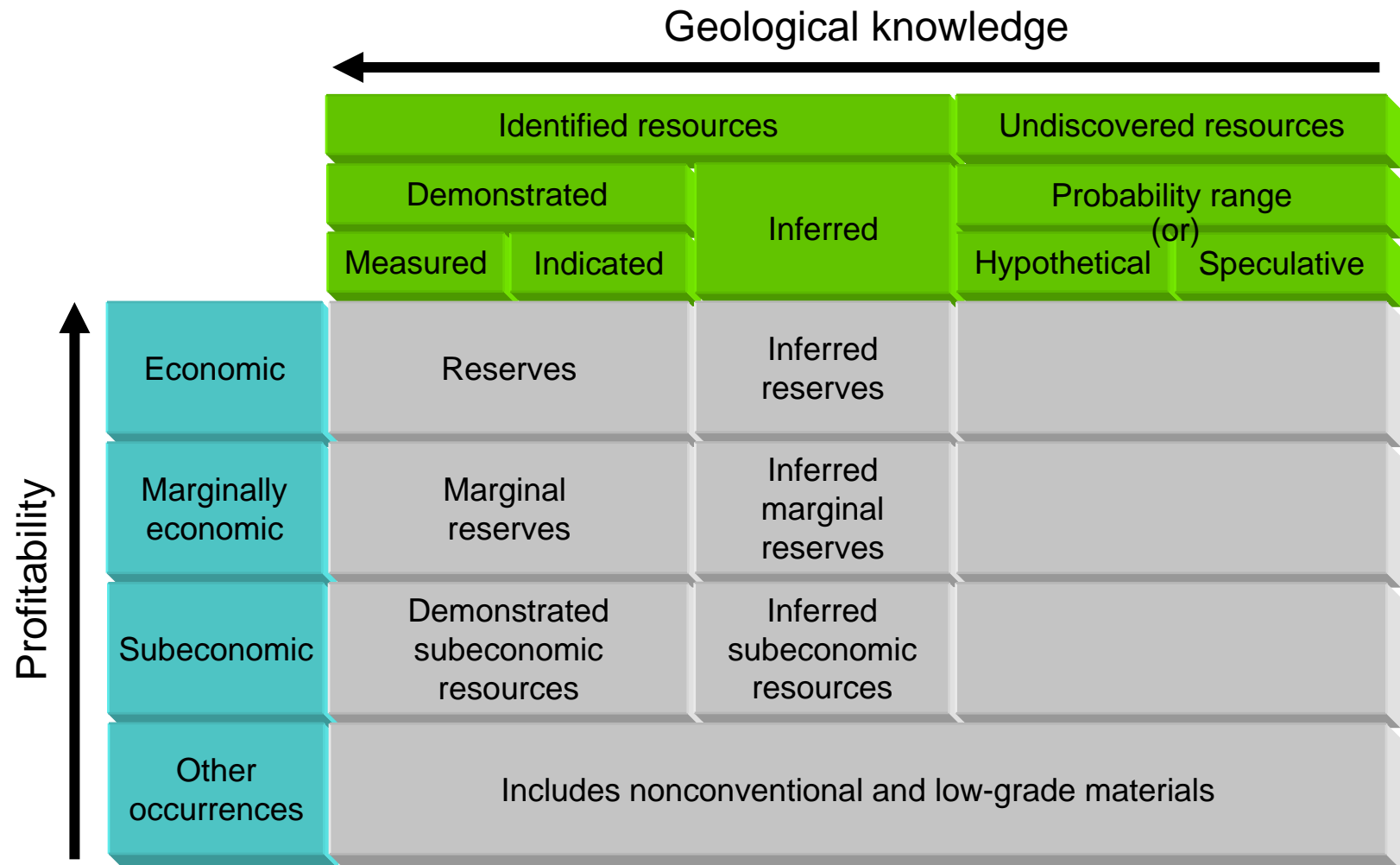



# MFA for Wood

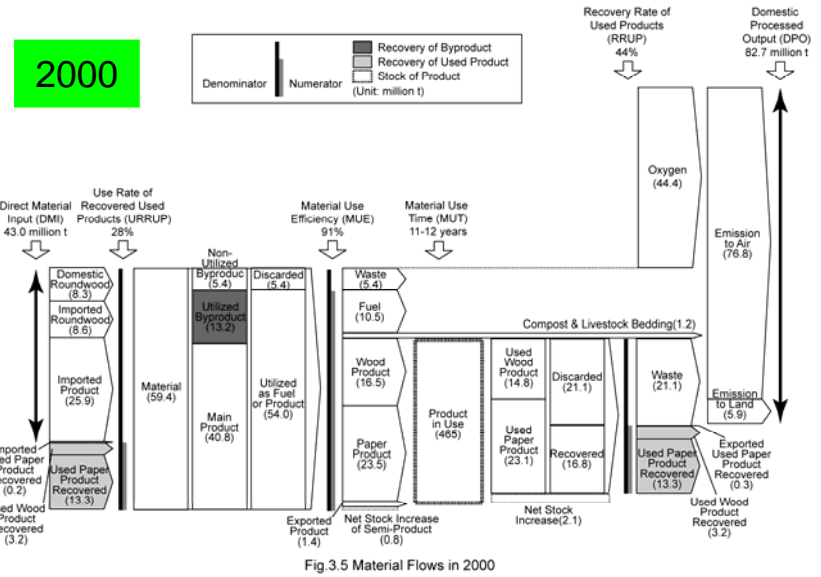
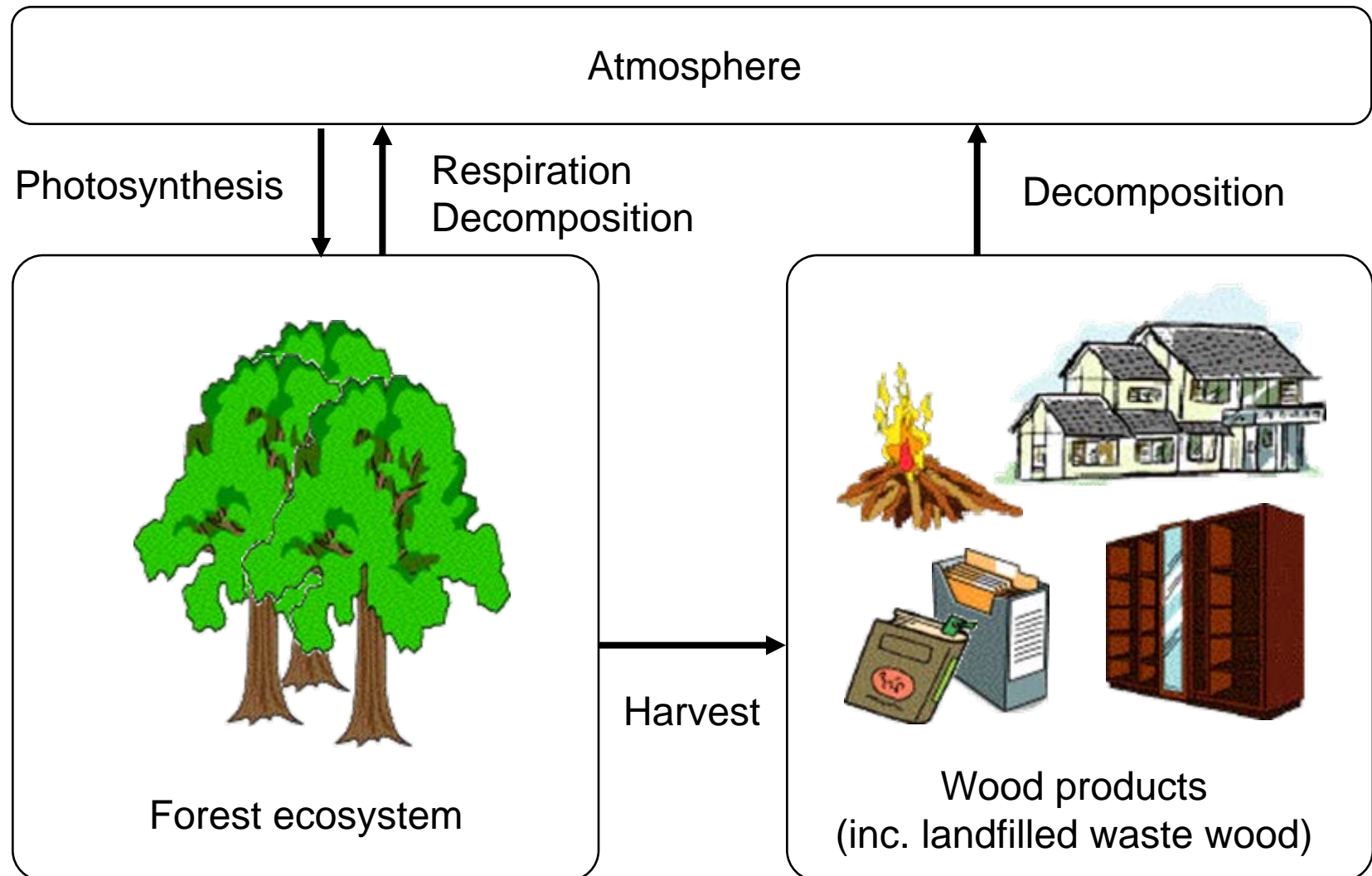

Fig.3.5 Material Flows in 2000

This section is based on Hashimoto and Moriguchi (2004) Data Book: Material and Carbon Flow of Harvested Wood in Japan (No. D034-2004) ([http://www-cger.nies.go.jp/cger-e/e\\_report/r\\_index-e.html](http://www-cger.nies.go.jp/cger-e/e_report/r_index-e.html)); Hashimoto et al. (2004) Six indicators of material cycles for describing society's metabolism: application to wood resources in Japan. *Resources, Conservation & Recycling* 40(3), 201-223; and Hashimoto et al. (2002) Wood products: potential carbon sequestration and impact on net carbon emissions of industrialized countries. *Environmental Science & Policy* 5(2), 183-193

# Forest sector carbon cycle

## Forest sector carbon cycle



# Forest sector carbon cycle

## Carbon stock in wood products

Carbon stock increase in wood products

**139 MtC/yr** in 1990 (Winjum et al., 1998)

**117 MtC/yr** in 1990 (Hashimoto et al., 2002)

**30–60 MtC/yr** in 1960–2000 (Pingoud et al., 2003:

landfilled waste wood not included)

**2%** of **6,400 Mt/yr** of global carbon emissions from fossil fuels and cement production in 1990s

**10%** of **1,000 Mt/yr** of global carbon stock change in vegetation, soil, and detritus in 1990s

Carbon stock in wood products

**3,300 MtC** in 2000 (Pingoud et al., 2003:

landfilled waste wood not included)

**Less than 1%** of **2,300,000 Mt** of global carbon stock in vegetation, soil, and detritus

**1%** of **500,000 Mt** of global carbon stock in vegetation



# Carbon stock increase in wood products

Estimation based on FAO data

Estimated carbon stock increase in 16 industrialized countries (1990)

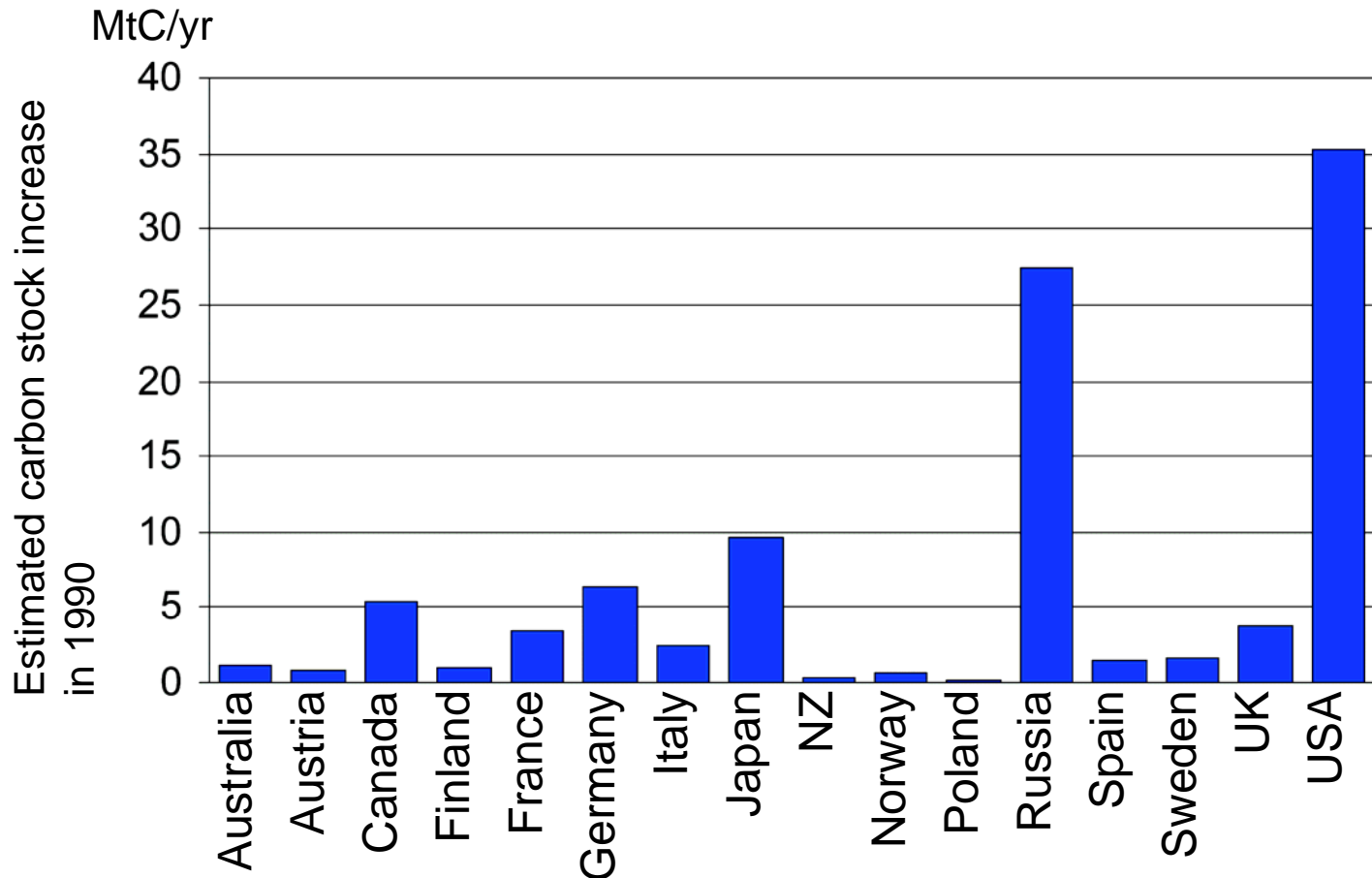

# Carbon stock increase in wood products

Estimation based on FAO data

The ratios of carbon stock increase to emissions (1990)

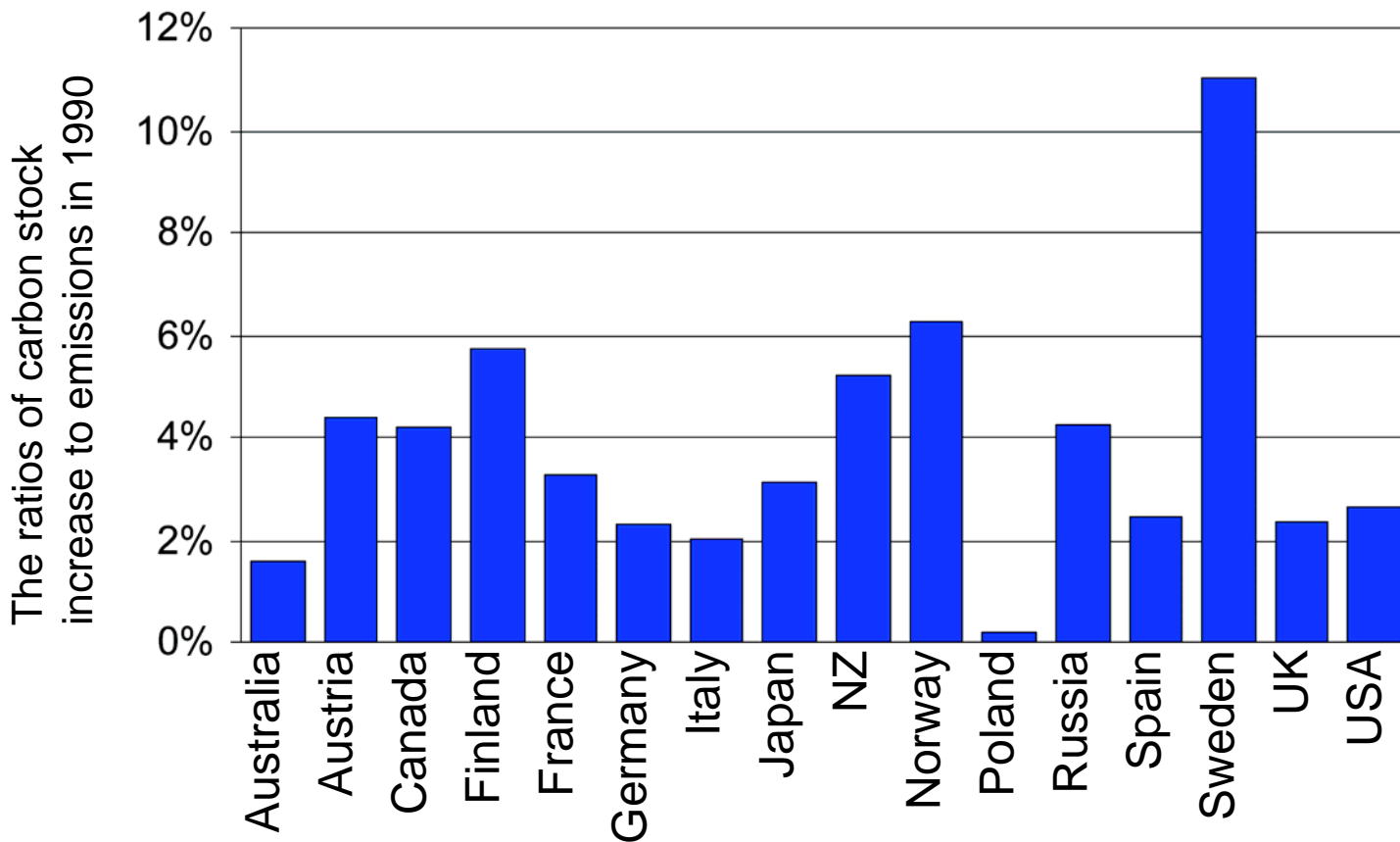

# Estimated flows of wood in Japan

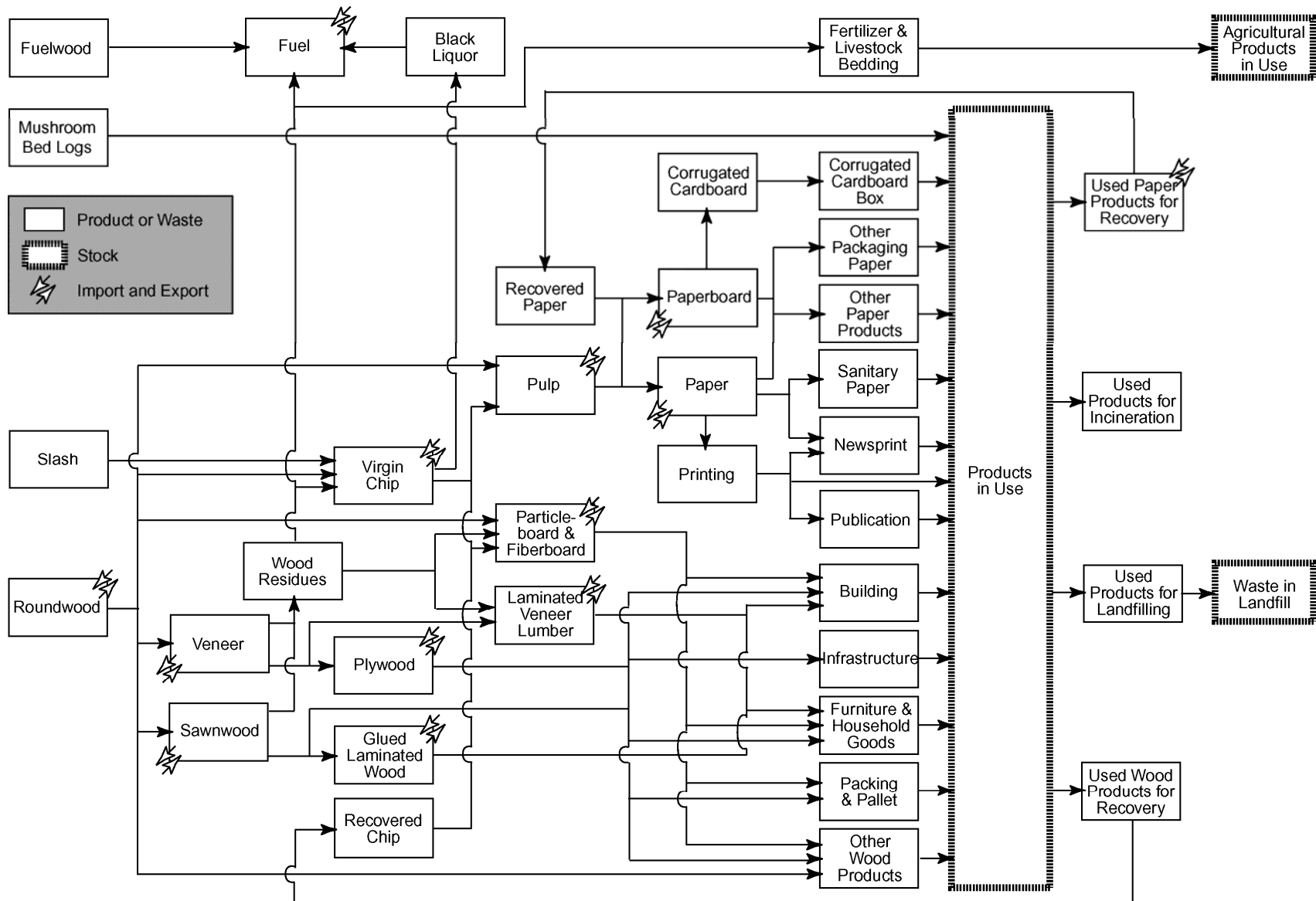

# Developed data base for wood

## Matrix presenting material and carbon flows

32 sectors of production activity



The table is a large matrix with a grid of cells. The columns are labeled at the top with 32 different production sectors, and the rows are labeled on the left with 48 different products, byproducts, wastes, and resources. The cells contain numerical data representing the flows between these sectors and products.

48 sectors of products, byproducts, wastes, and resources





# Detailed material and carbon flow data for Japan

## Material flows in 1960

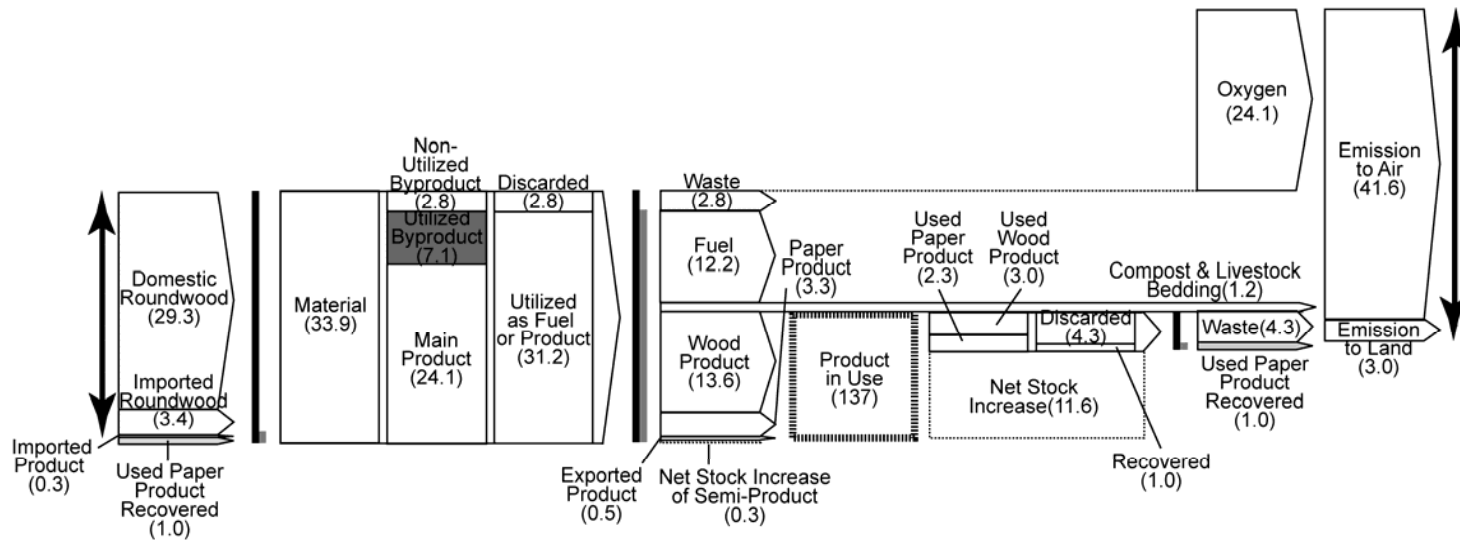



# Detailed material and carbon flow data for Japan

## Material flows in 1970

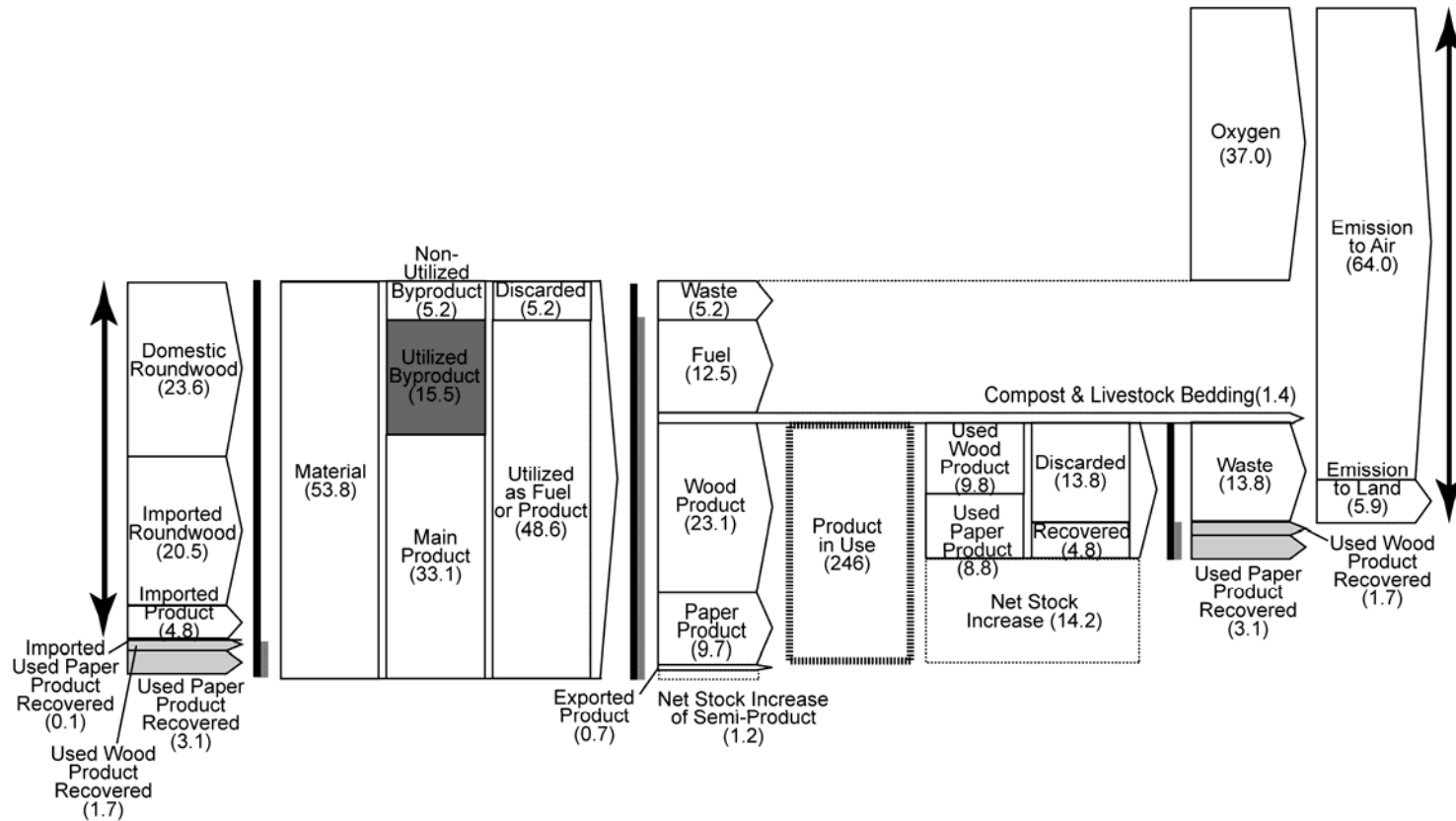

# Detailed material and carbon flow data for Japan

## Material flows in 1980

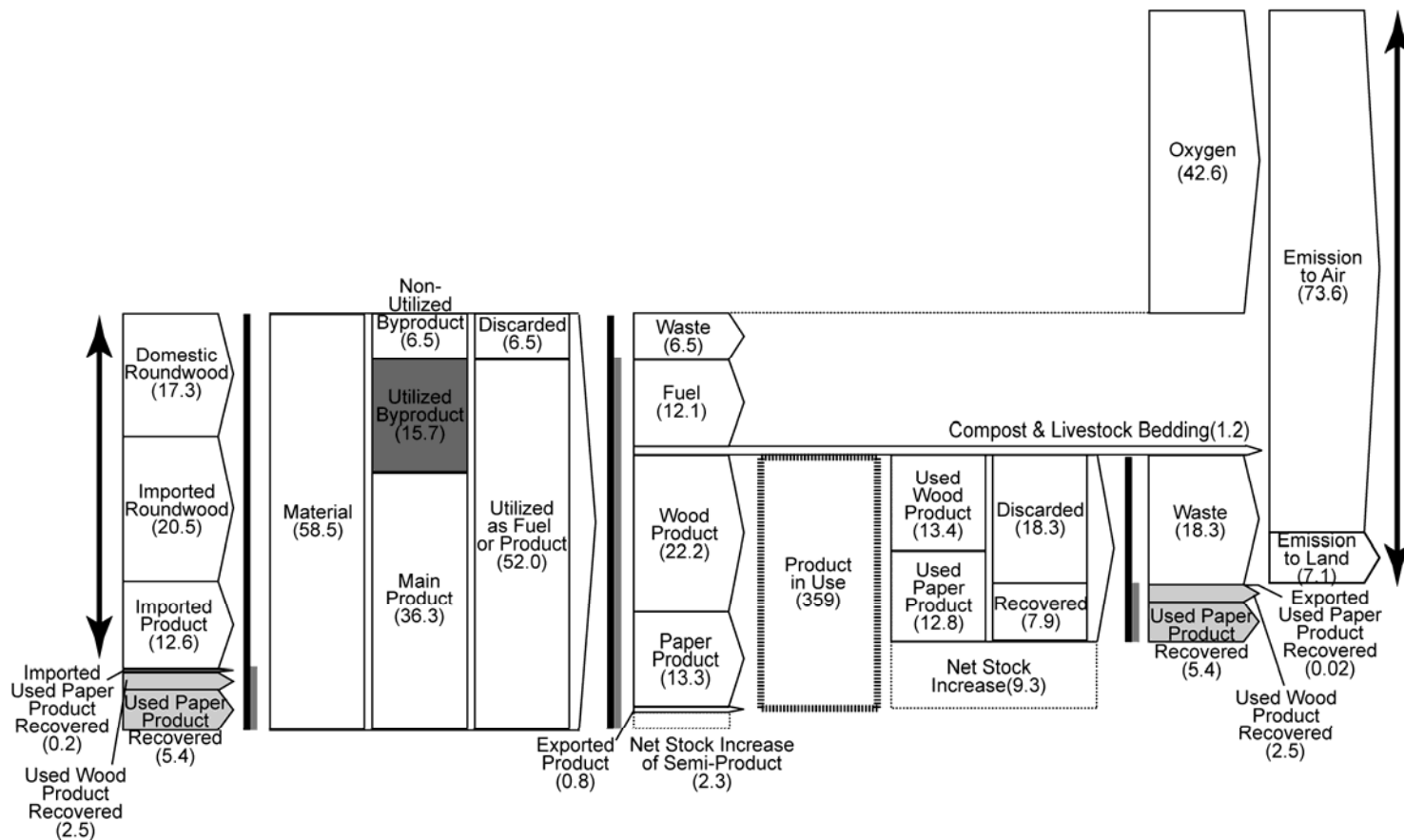

# Detailed material and carbon flow data for Japan

## Material flows in 1990

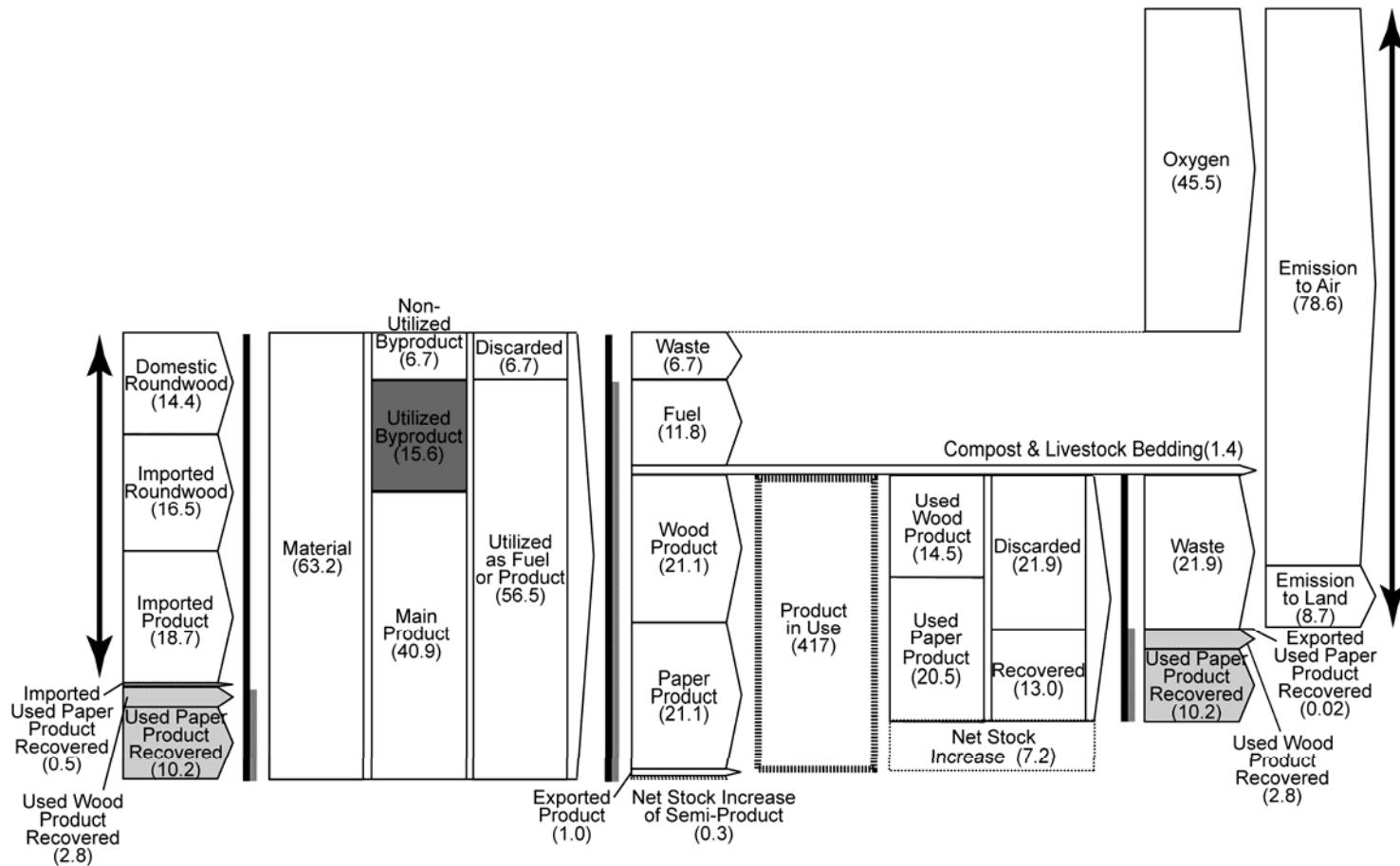

# Detailed material and carbon flow data for Japan

## Material flows in 2000

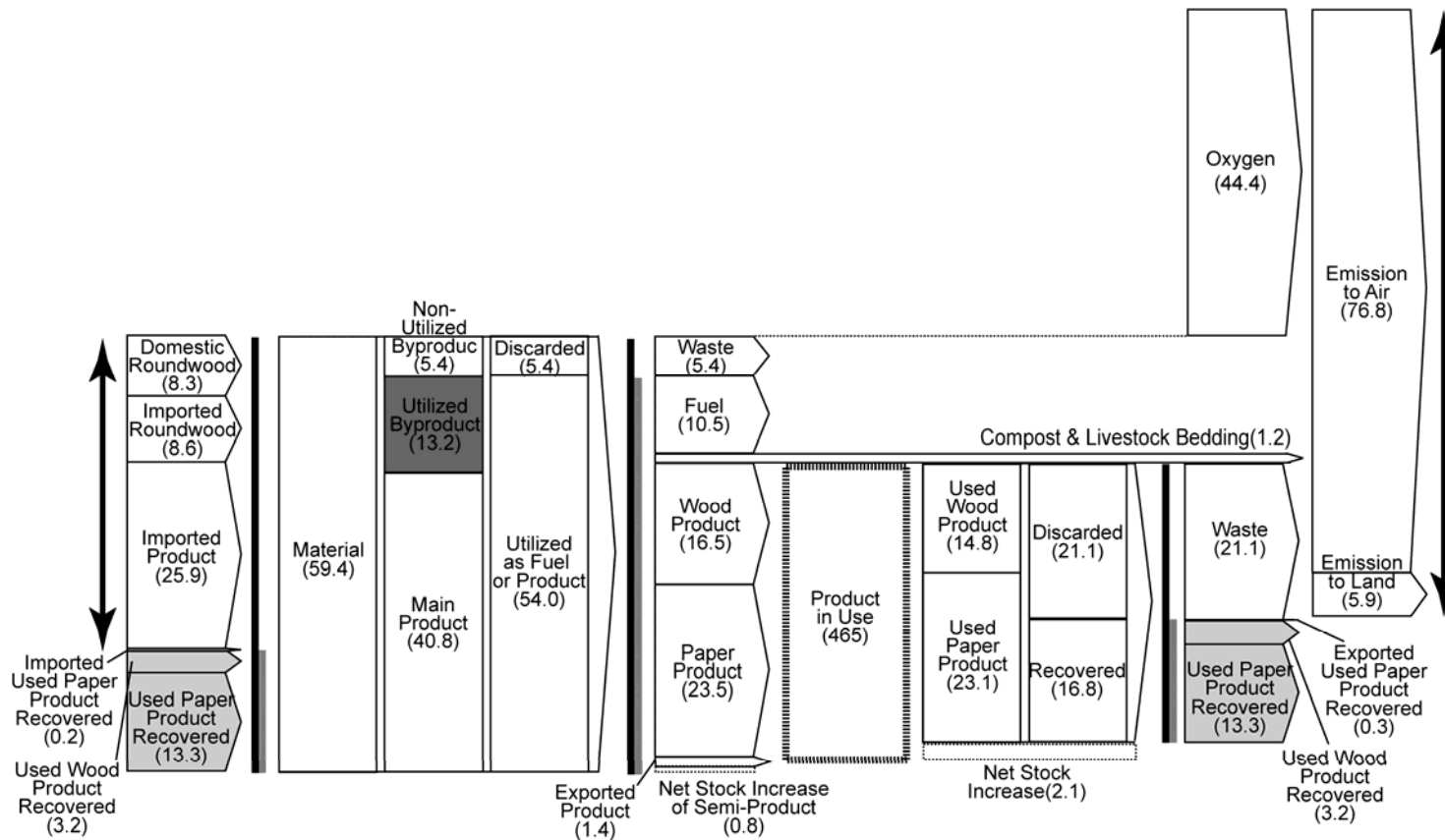

# Detailed material and carbon flow data for Japan

## Overview of transition of wood use

# Increased use as paper  
 # Increased emissions to the environment  
 # Increased recycling

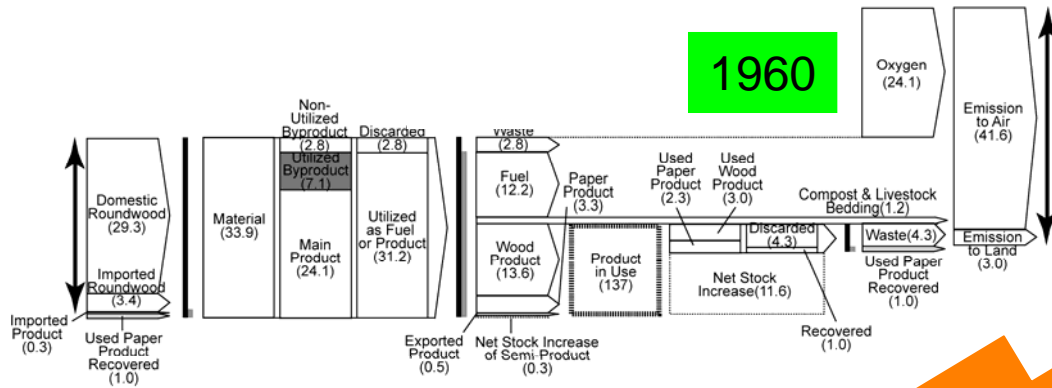

Fig.3.1 Material Flows in 1960

# Increased use of wood resources  
 # Increased import of roundwood and products

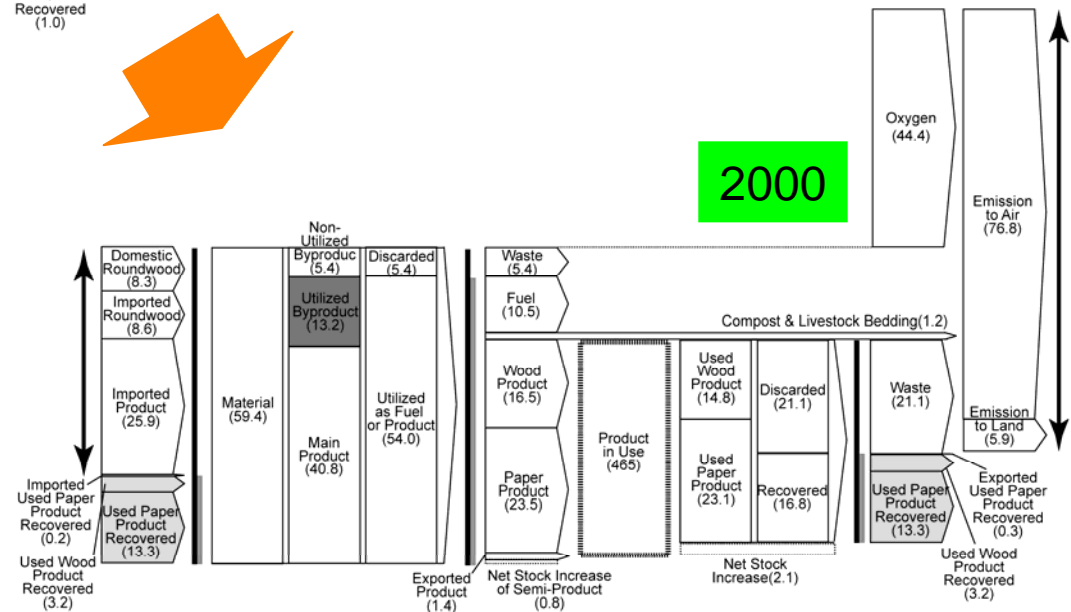
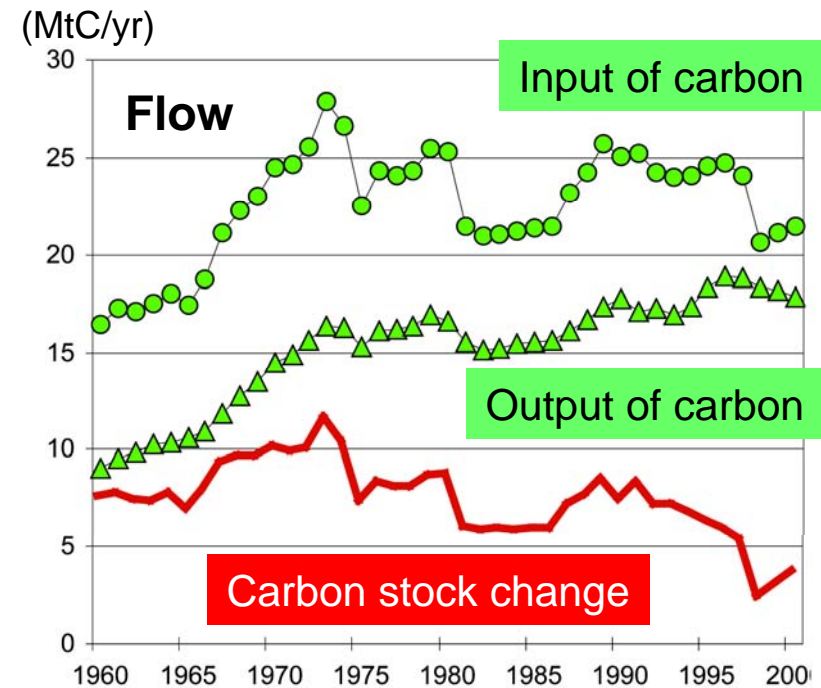
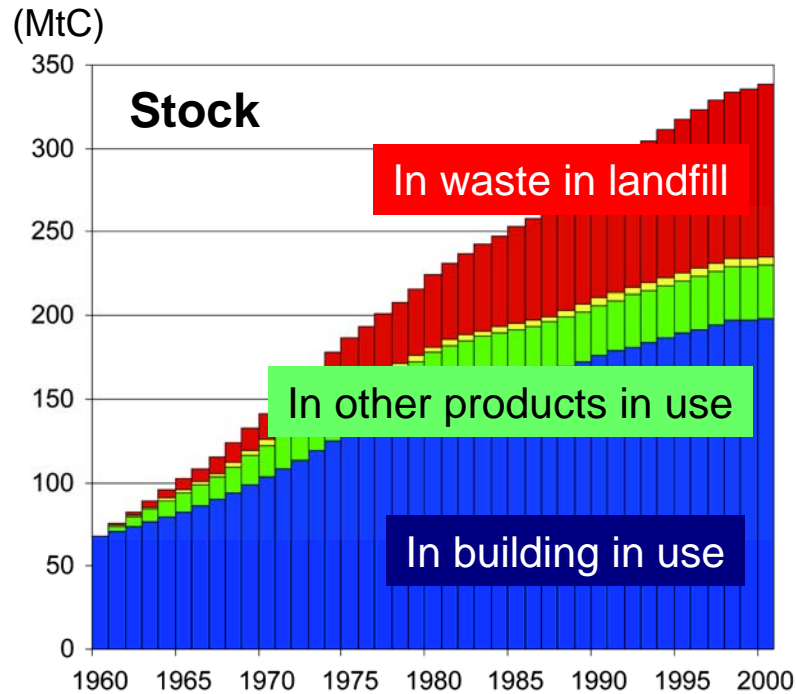

Fig.3.5 Material Flows in 2000



# Detailed material and carbon flow data for Japan

## Carbon stocks and flows in wood products



Increasing carbon stock in products in use and wastes in landfills

Declining increase in carbon stock (correspond to 2% to 1% of emissions)

# Today's talk

## ❑ What is “Junkan-Gata Society”?

- A driving force of expansion of material flow studies in Japan

## ❑ Topic 1: National material flow indicators and targets

- Outline, background, and ongoing discussion on policies related to the use of national material flow indicators

## ❑ Topic 2: MFA for construction minerals

- Dominate input materials and Net Additions to Stock (NAS) of national MFA

## ❑ Topic 3: Classification of stocked materials

- For future waste management and resource reutilization

## ❑ Topic 4: MFA for wood

- As a case for carbon accounting

Thank you for your kind attention!

